

FÜR 400 SERIE > 196-180A600 (2008) > GRUNDGERÄT

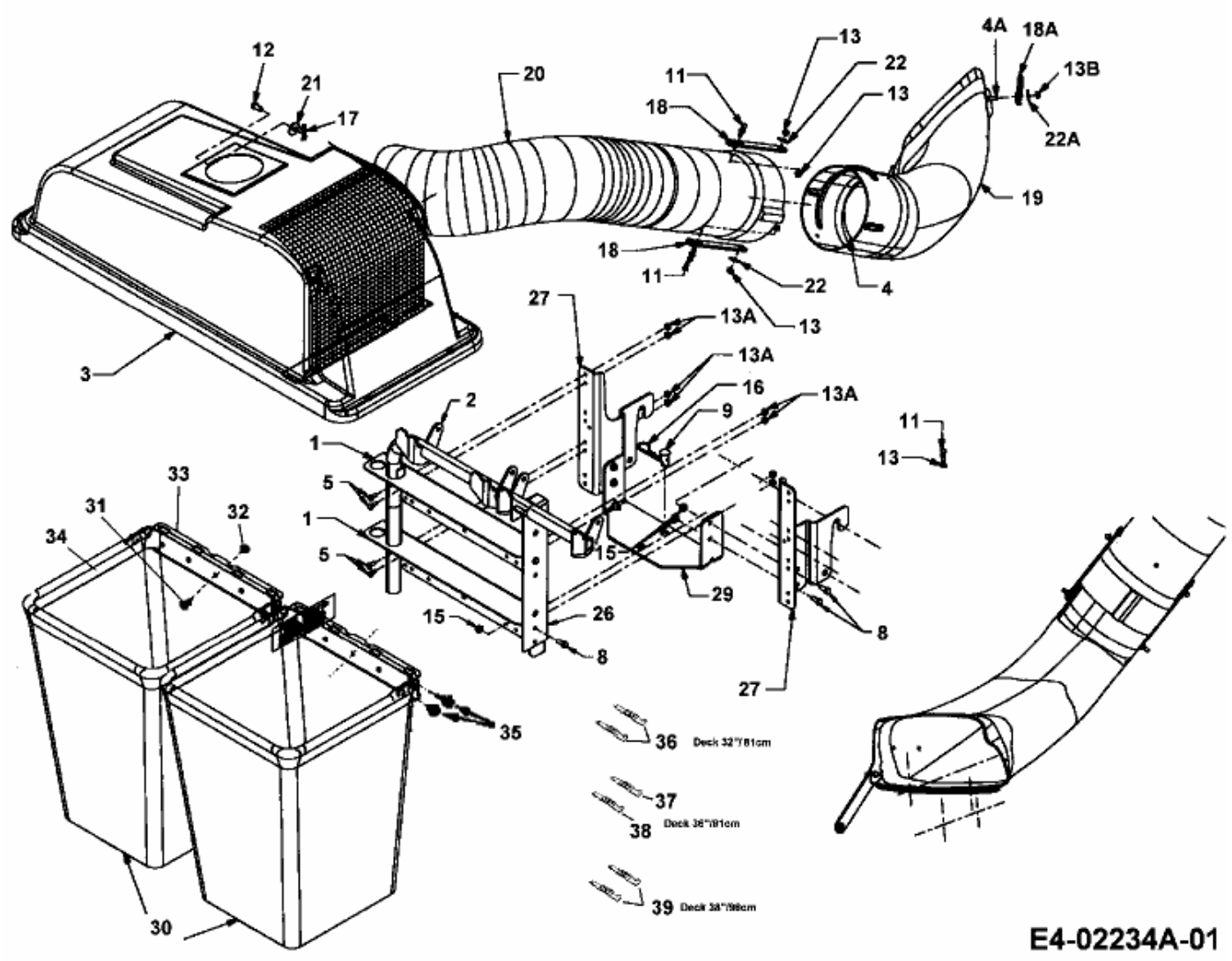

E4-02234A-01