

45-0528 (196-070-000) > 196-070-000 (2017) > GRUNDGERÄT

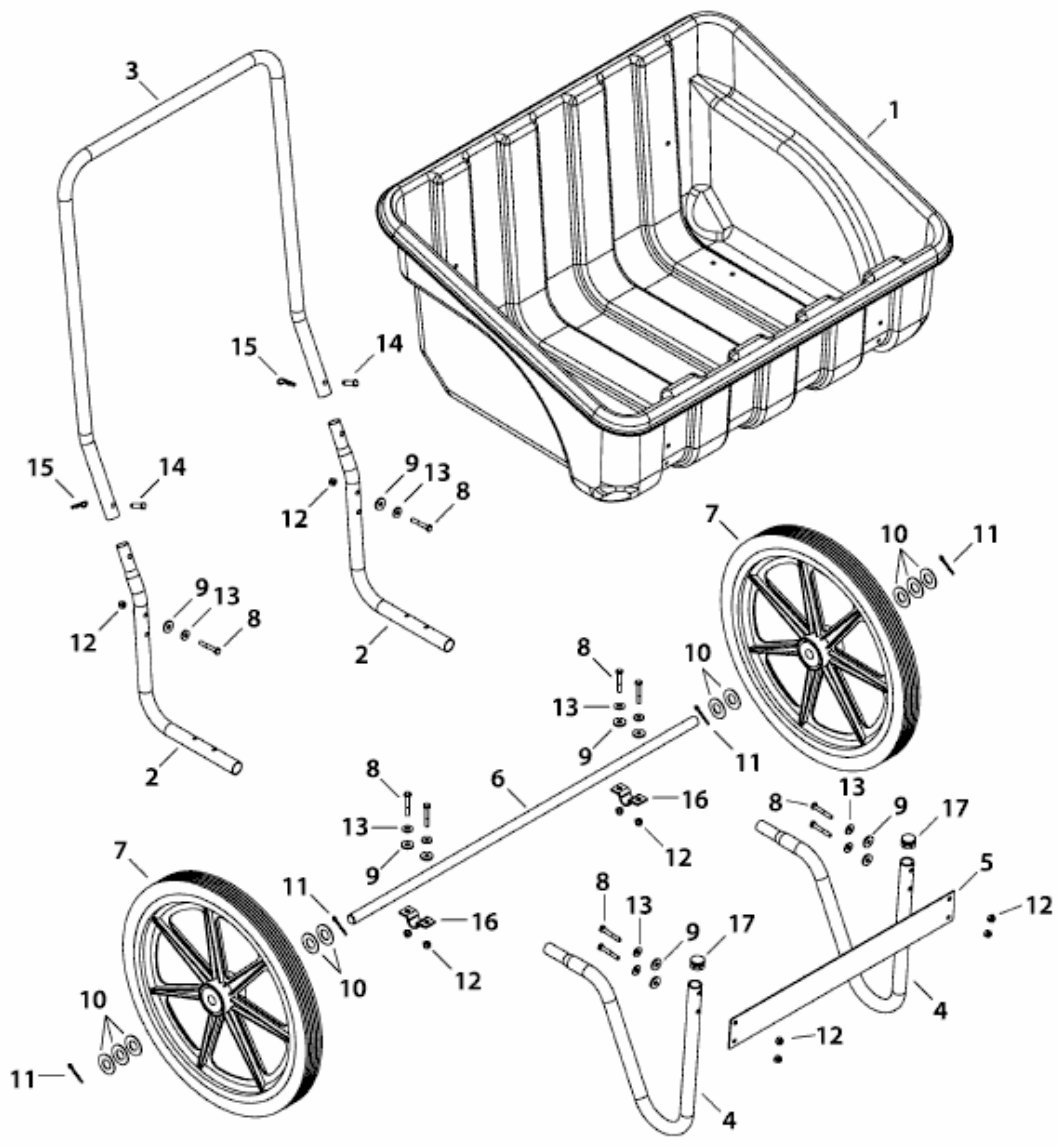

E3-10127A-01