

KEHRGUTBEHÄLTER 70 CM > 196-067-000 (2015) > GRUNDGERÄT

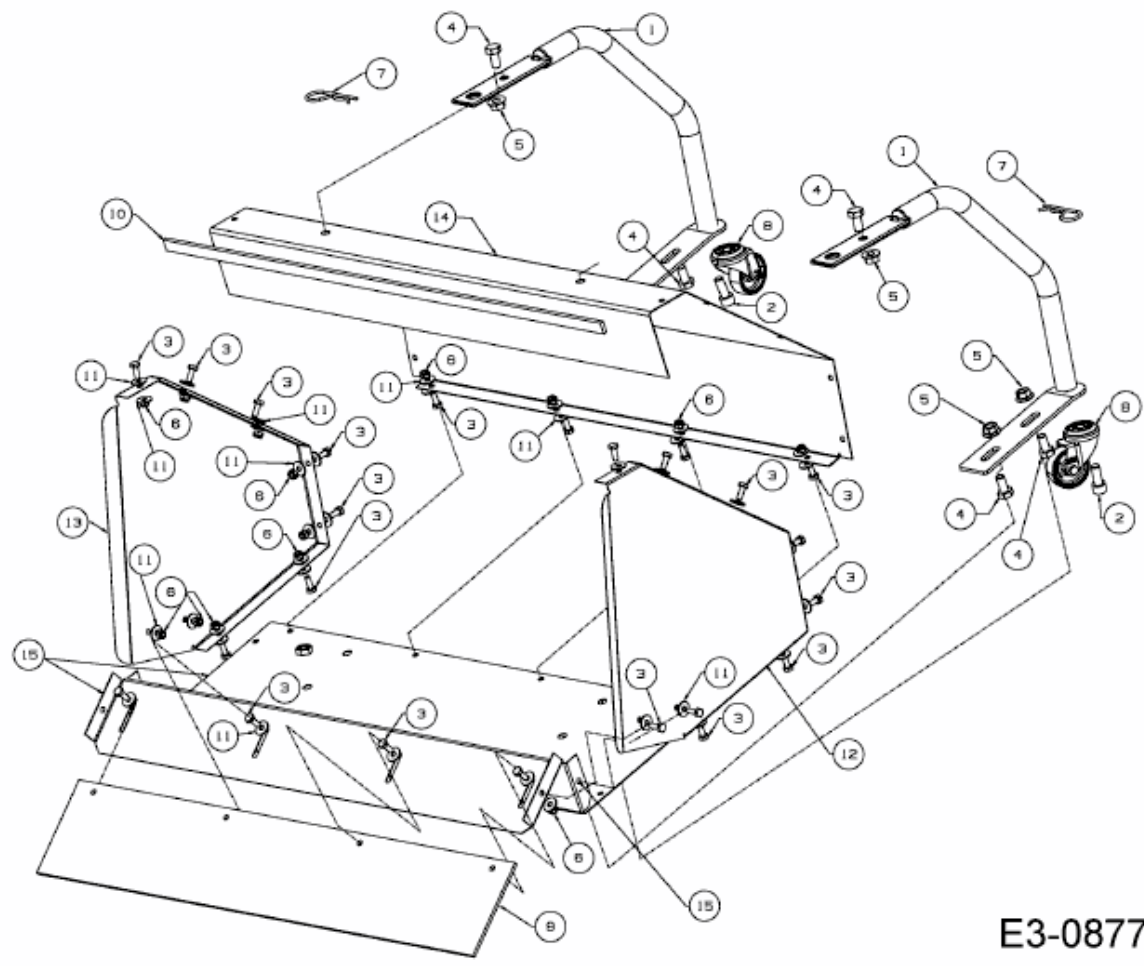

E3-08772A-01