

FÜR 400 SERIE > 196-065-698 (2001) > GRASFANGSACKDECKEL

Model 065

196-065-678

Grass Catcher Cover Assembly

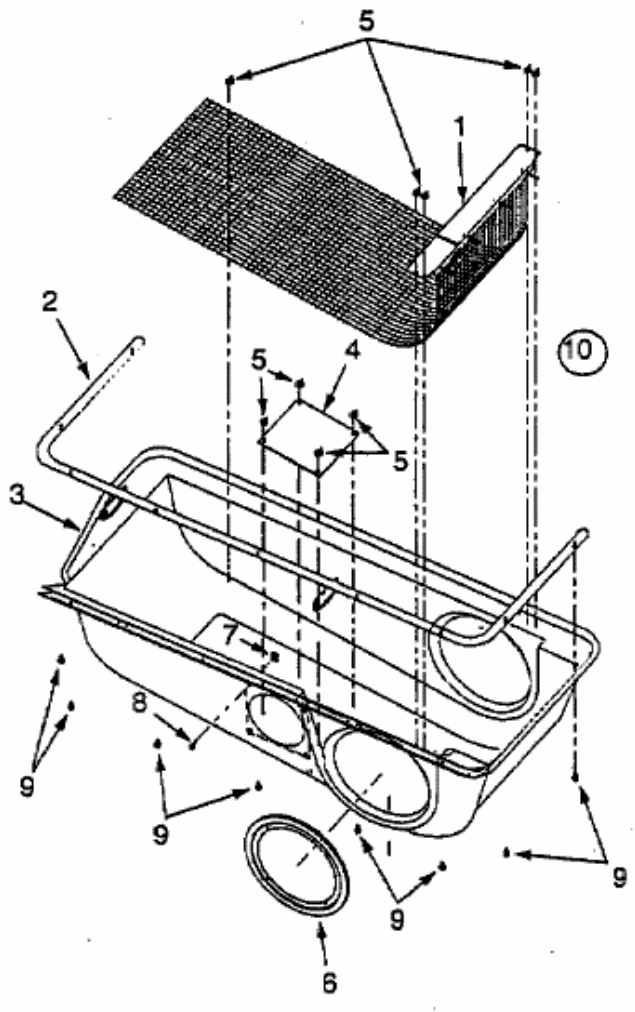

E4-01016A