

FÜR 400 SERIE > 196-065-678 (1999) > GRASFANGKORB

# Model 065

196-065-678

## Twin Bag

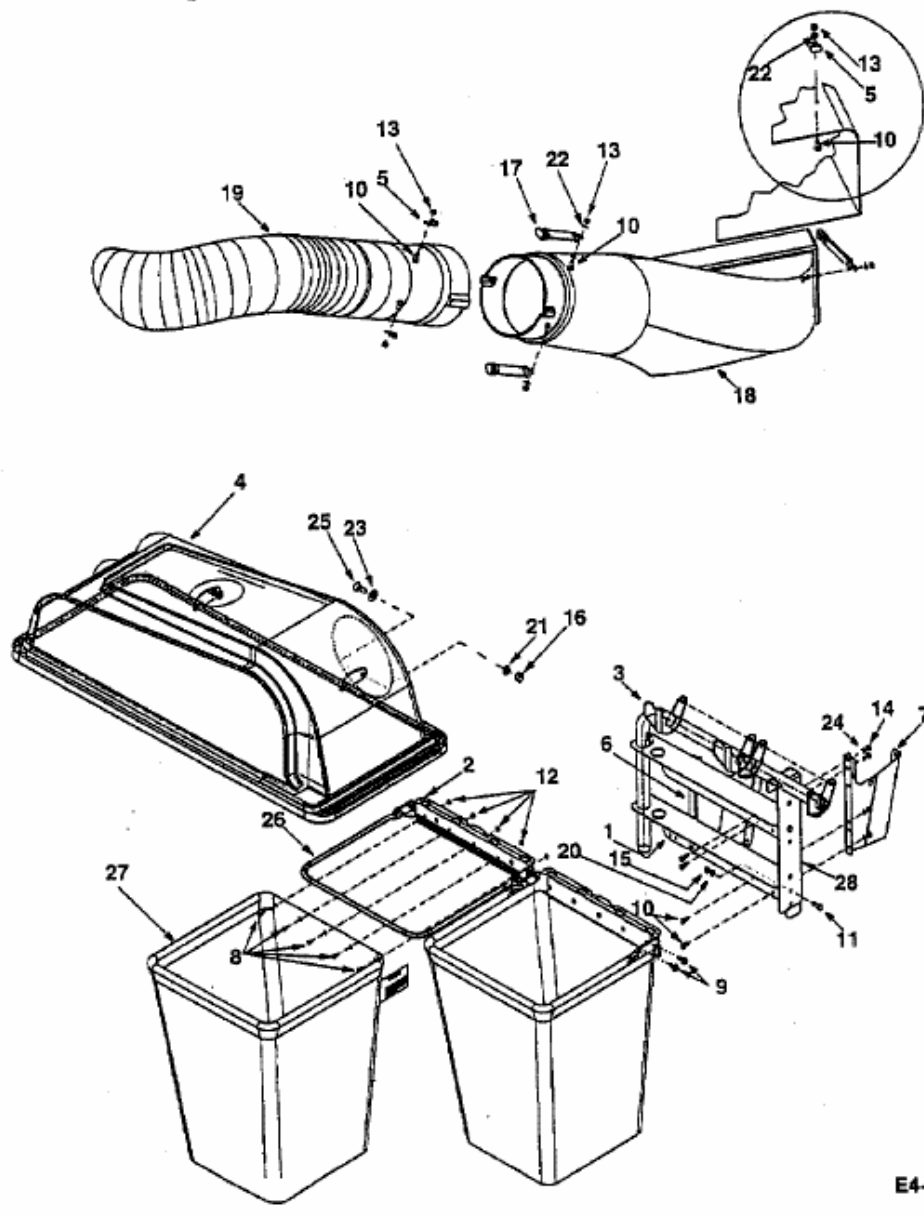

E4-01015A