

FÜR 400 SERIE > 196-065-678 (1998) > GRASFANGSACKDECKEL

Model 065

196-065-678

Grass Catcher Cover Assembly

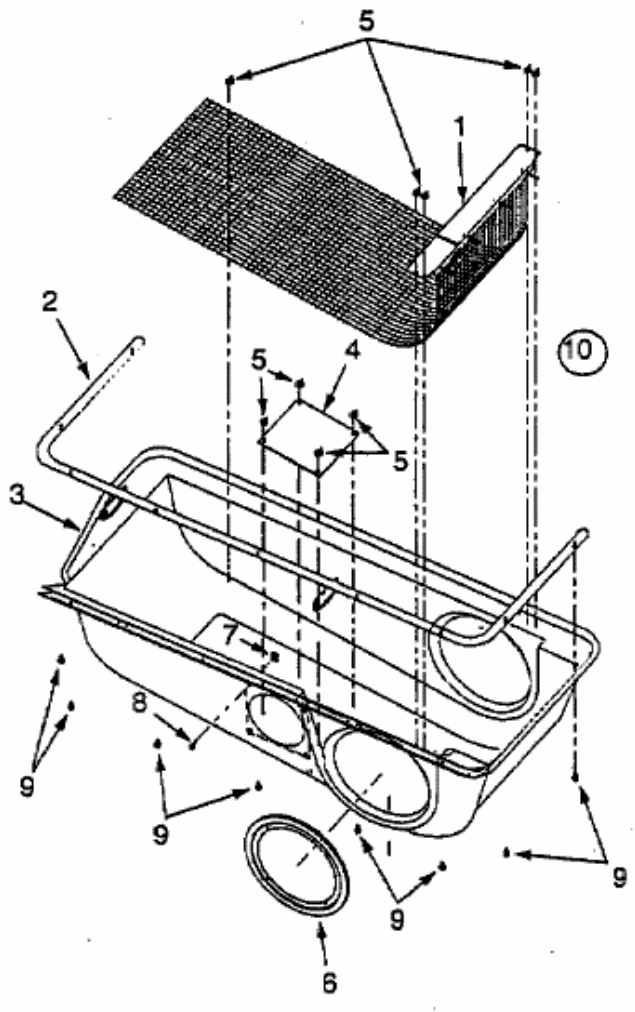

E4-01016A