

FÜR 400 SERIE > 196-065-600 (2003) > GRASFANGKORB

Model 065 Twin Bag

196-065-600

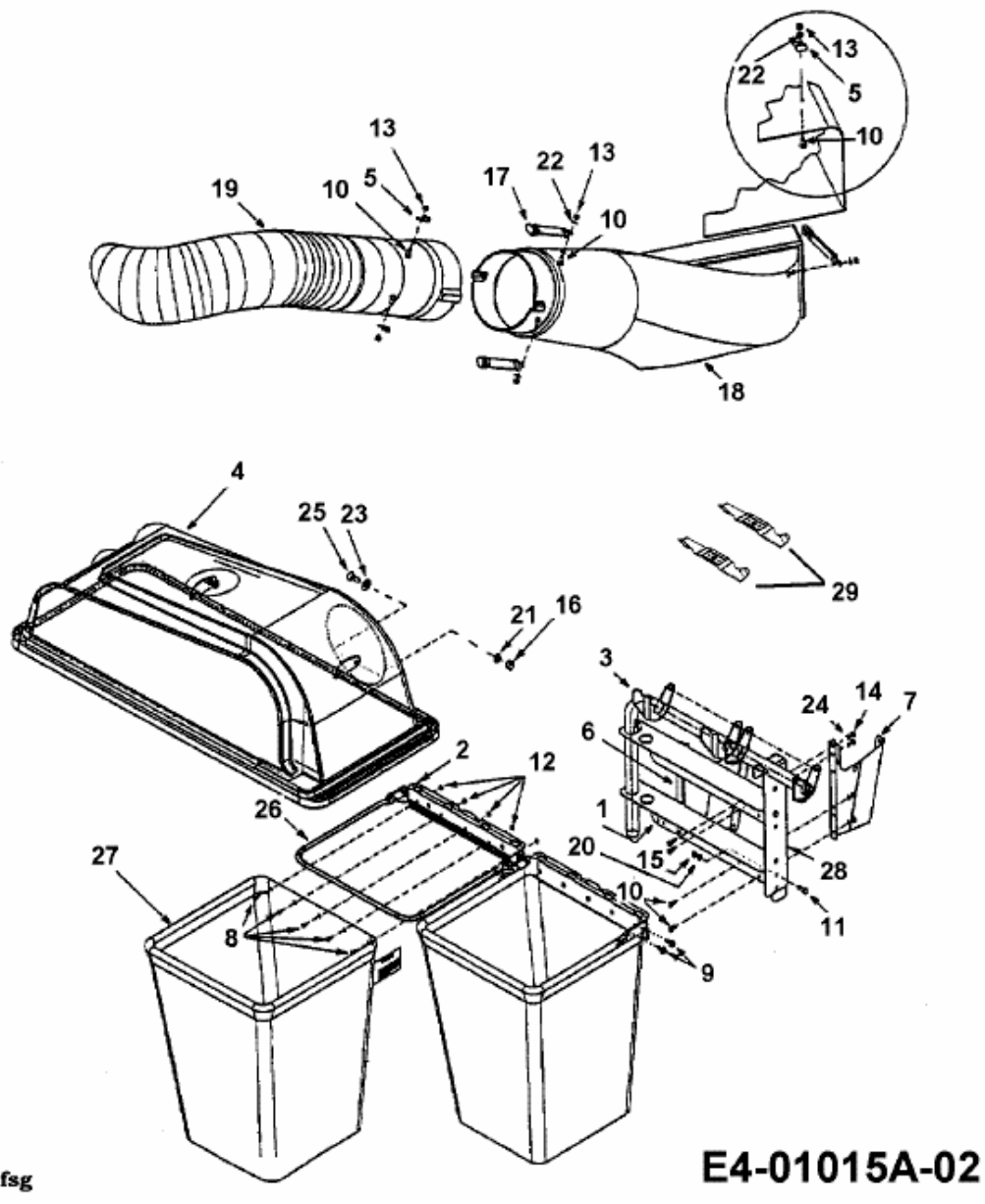

fsg

E4-01015A-02