

45-03012 (196-064-000) > 196-064-000 (2016) > GRUNDGERÄT

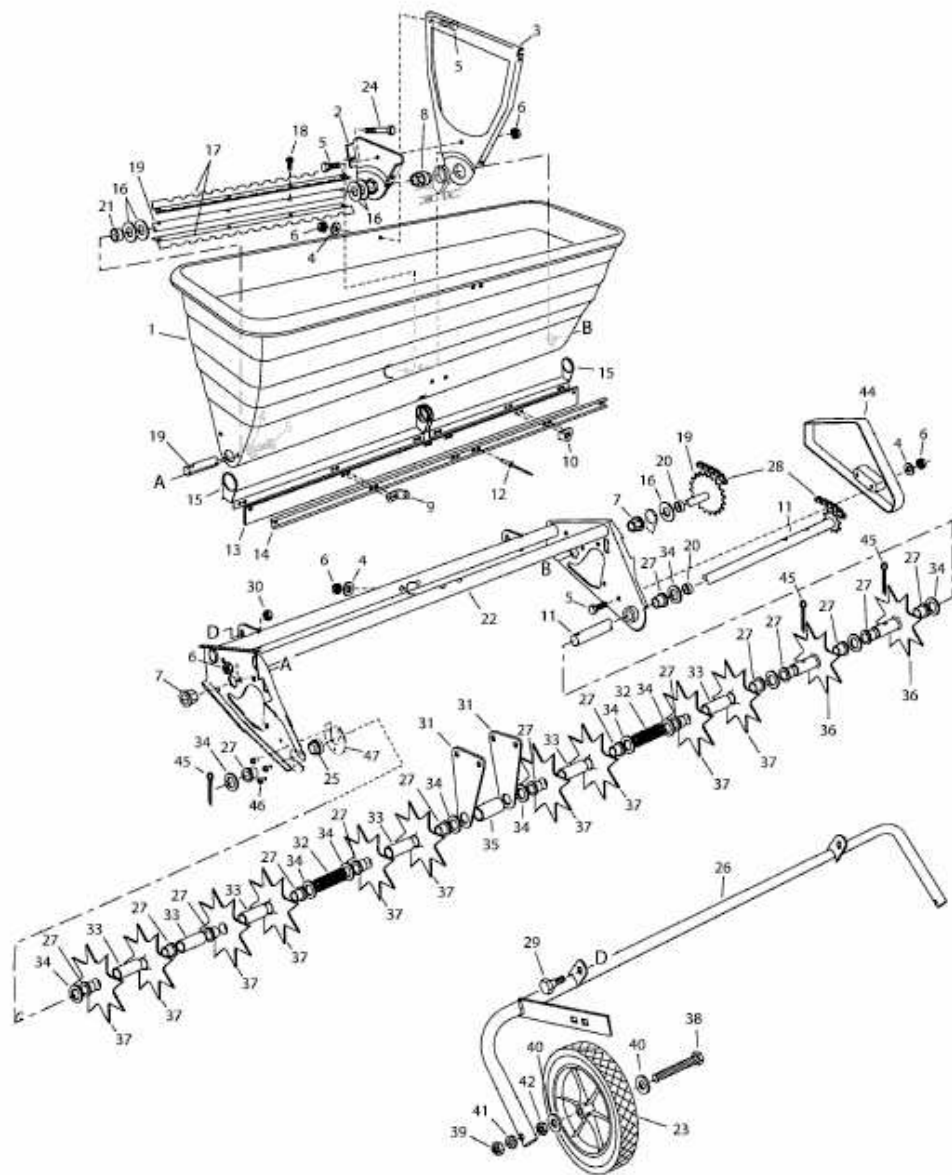

E3-09432C-02