

45-03011 (196-064-000) > 196-064-000 (2015) > GRUNDGERÄT

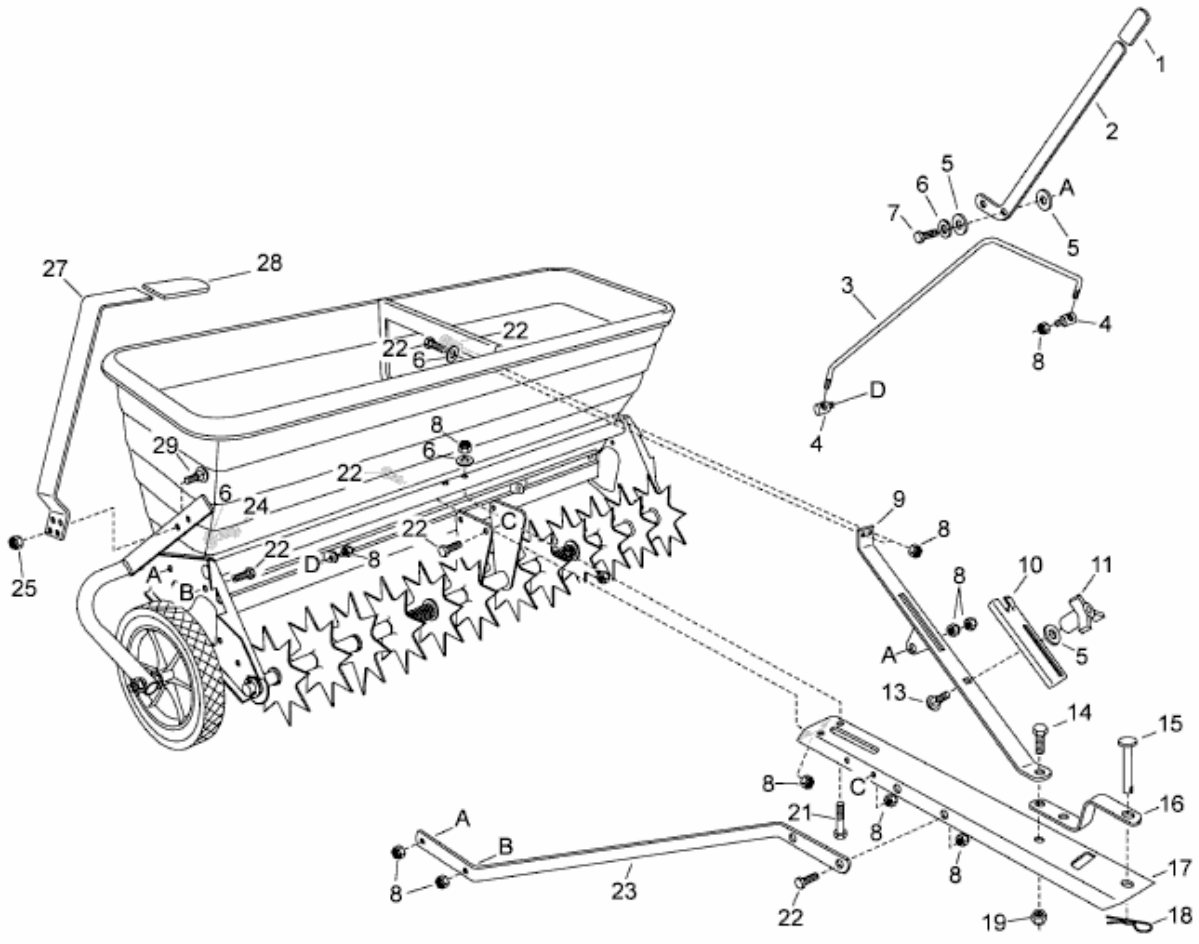

E3-09432B-01