

45-0301 (196-064-000) > 196-064-000 (2016) > GRUNDGERÄT

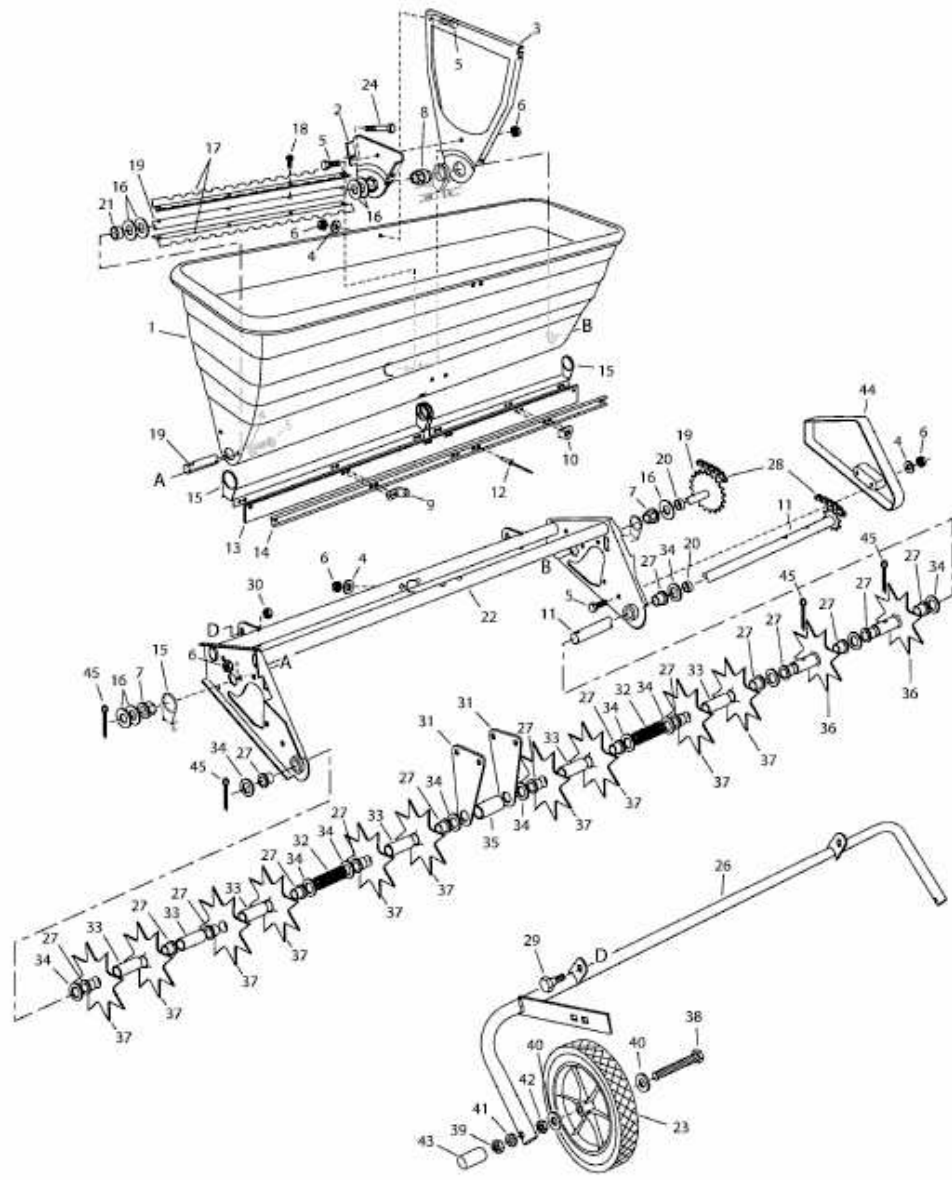

E3-09432A-02