

45-03881 (196-055-000) > 196-055-000 (2014) > GRUNDGERÄT

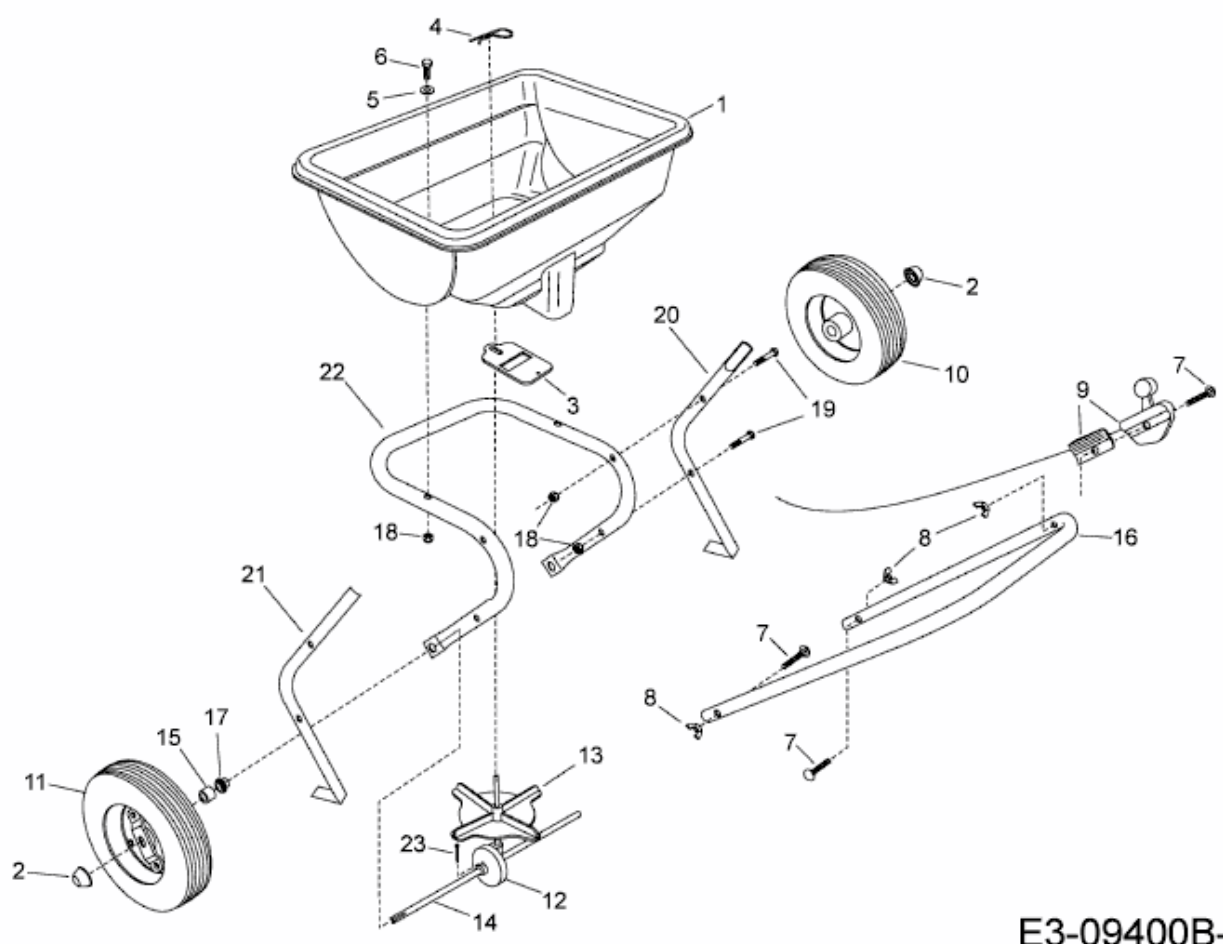

E3-09400B-01