

45-0388 (196-055-000) > 196-055-000 (2005) > GRUNDGERÄT

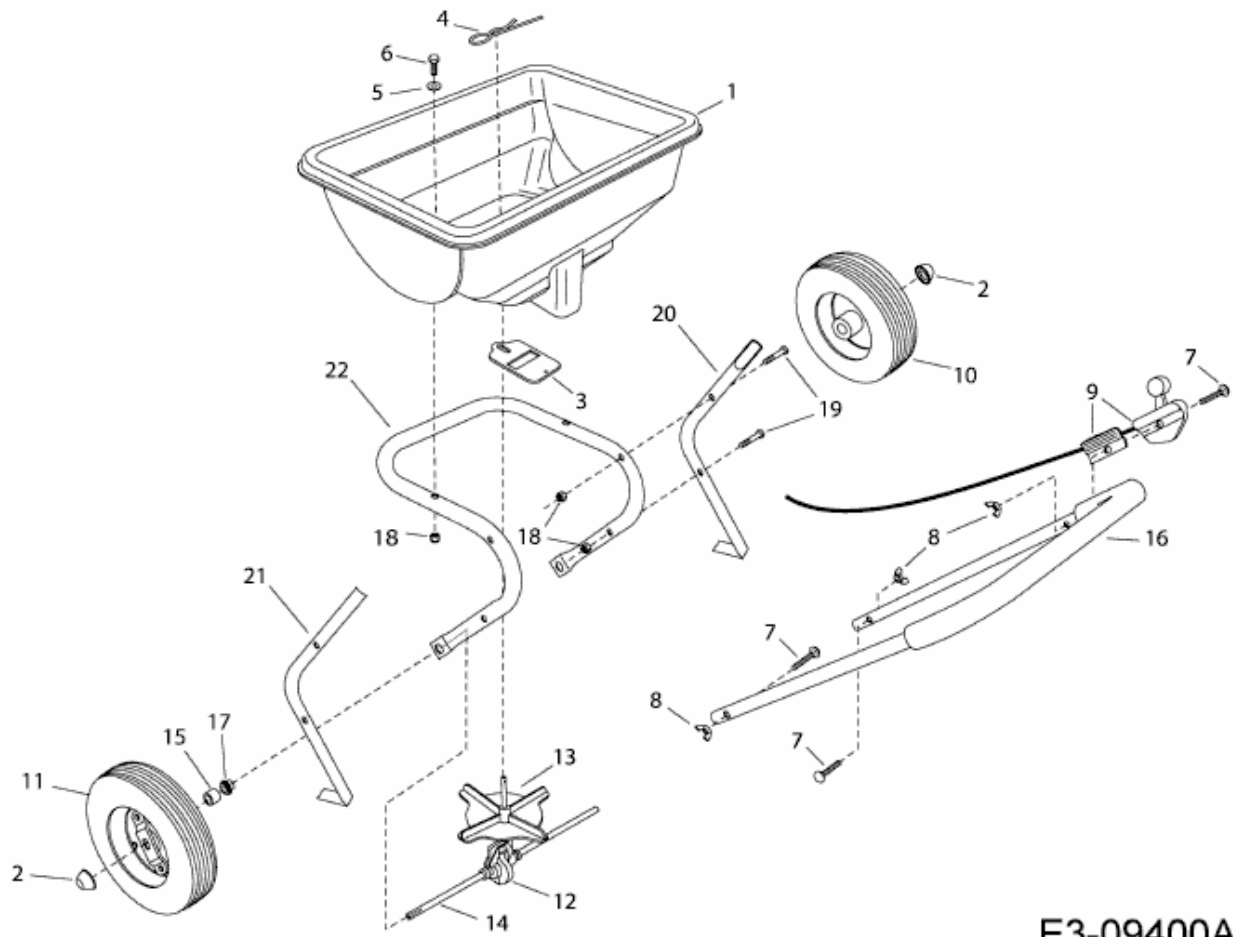

E3-09400A-01