

45-03296 (196-036-000) > 196-036-000 (2015) > GRUNDGERÄT

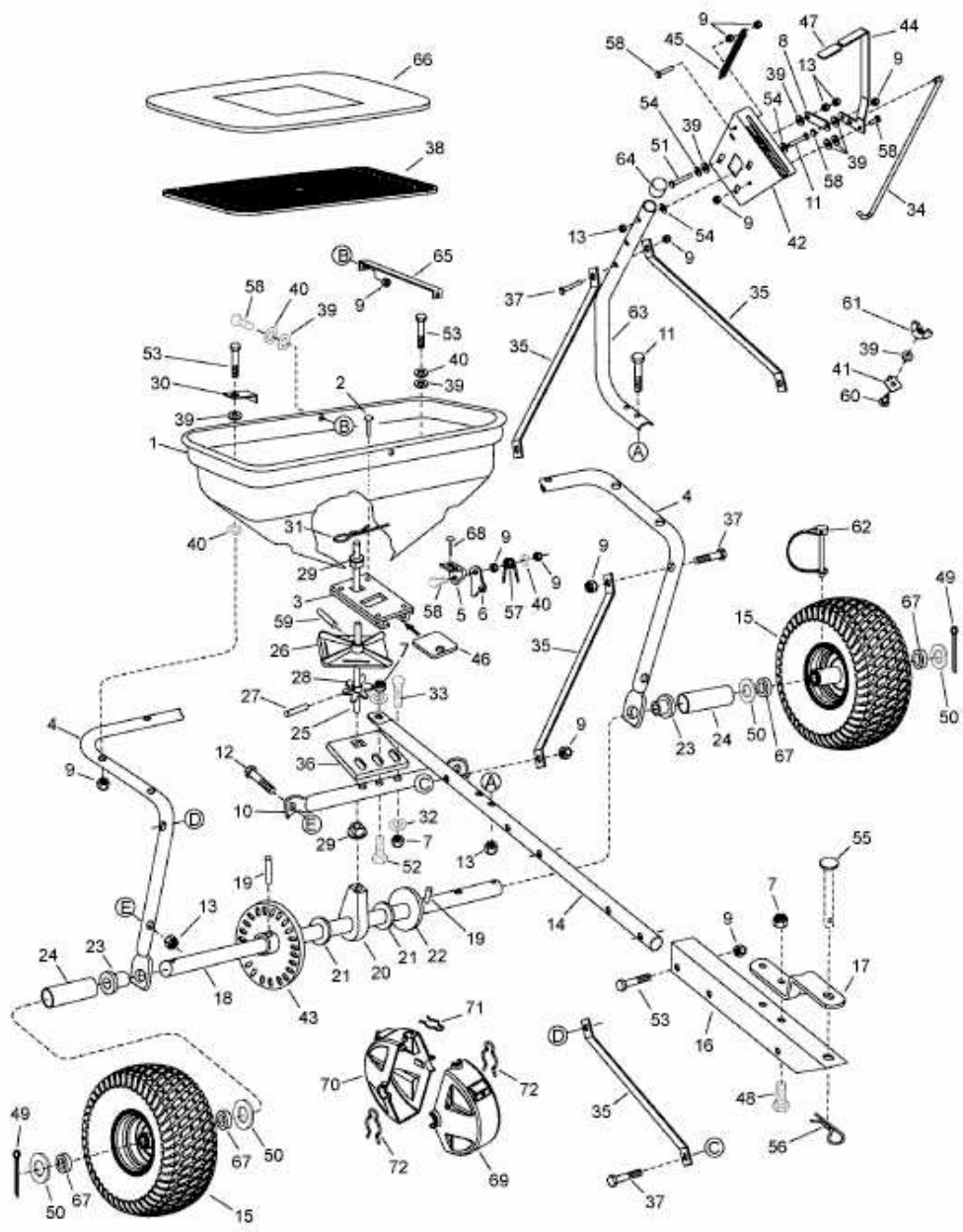

E3-07863A-05