

45-0309 (196-033-000) > 196-033-000 (2005) > GRUNDGERÄT

**MODEL 45-0309**

**32" POLY SPIKER/SPREADER**

196-033-000

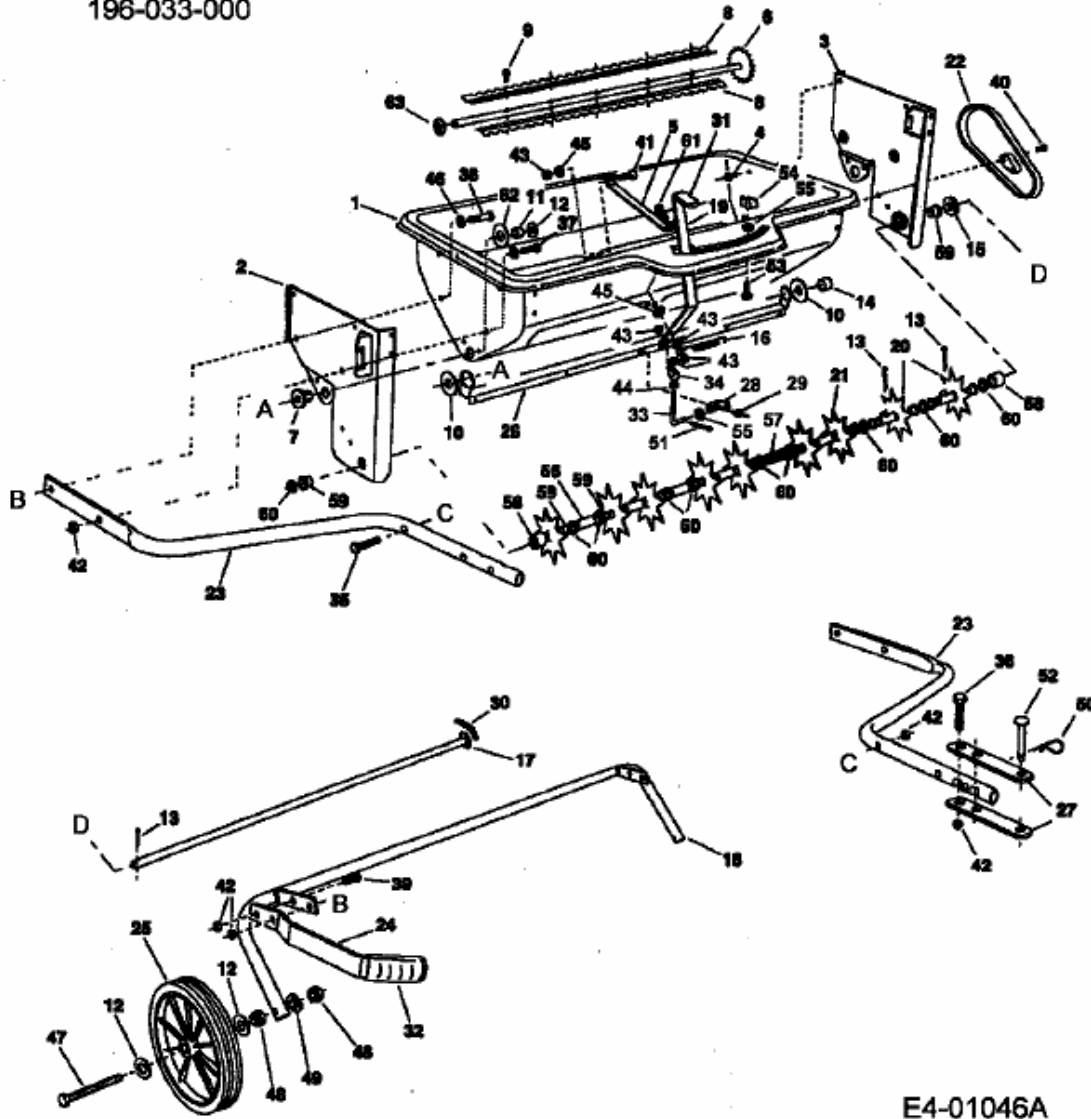

E4-01046A