

45-03153 (196-031-000) > 196-031-000 (2016) > GRUNDGERÄT

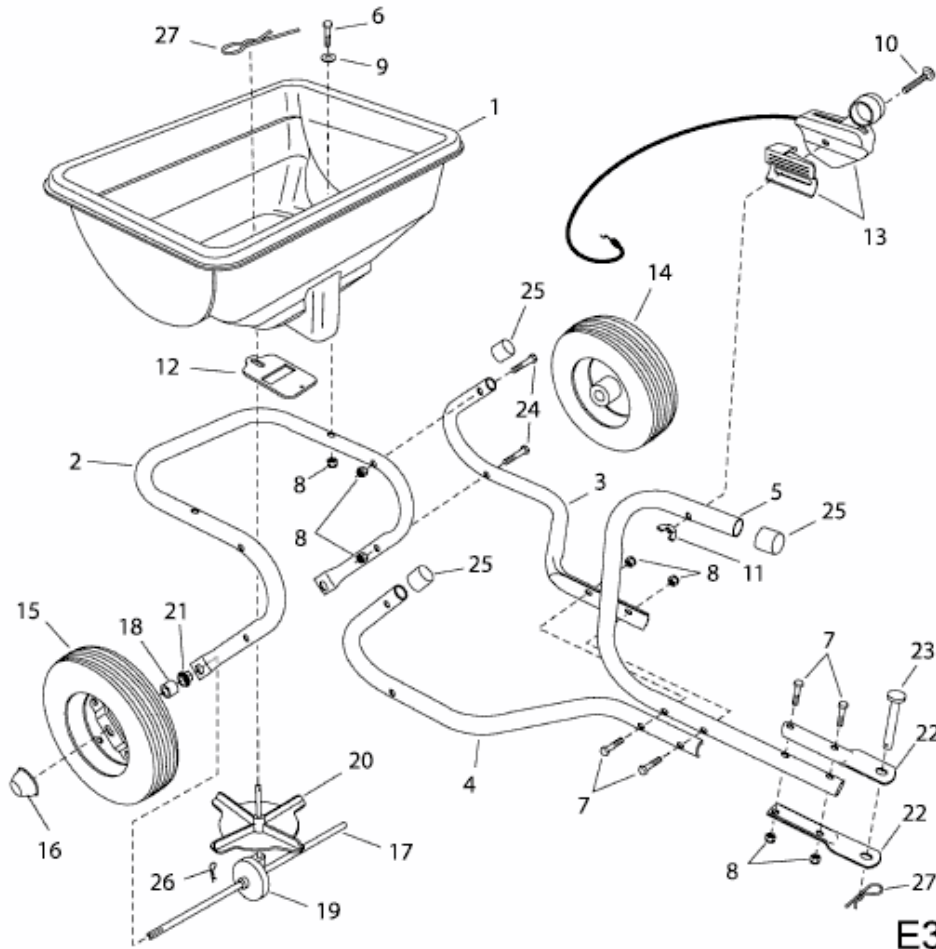

E3-09986A-01