

45-03153 (196-031-000) > 196-031-000 (2014) > GRUNDGERÄT

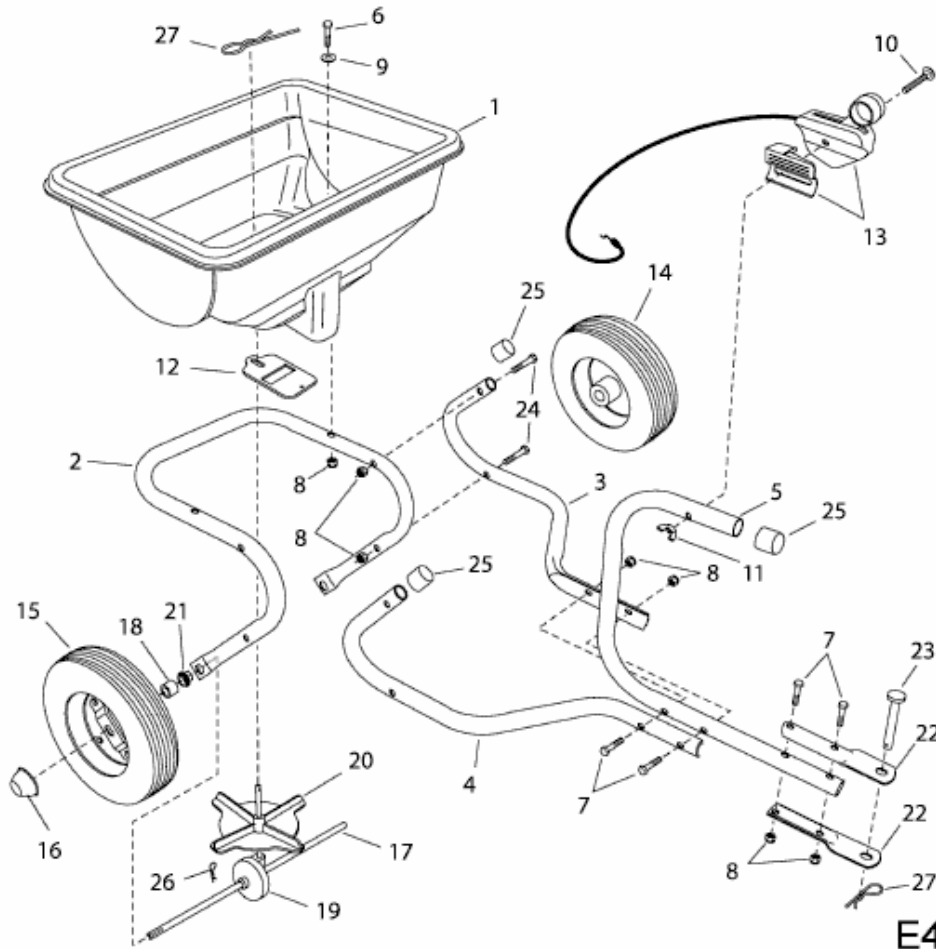

E4-02632A-01