

45-03152 (196-031-000) > 196-031-000 (2009) > GRUNDGERÄT

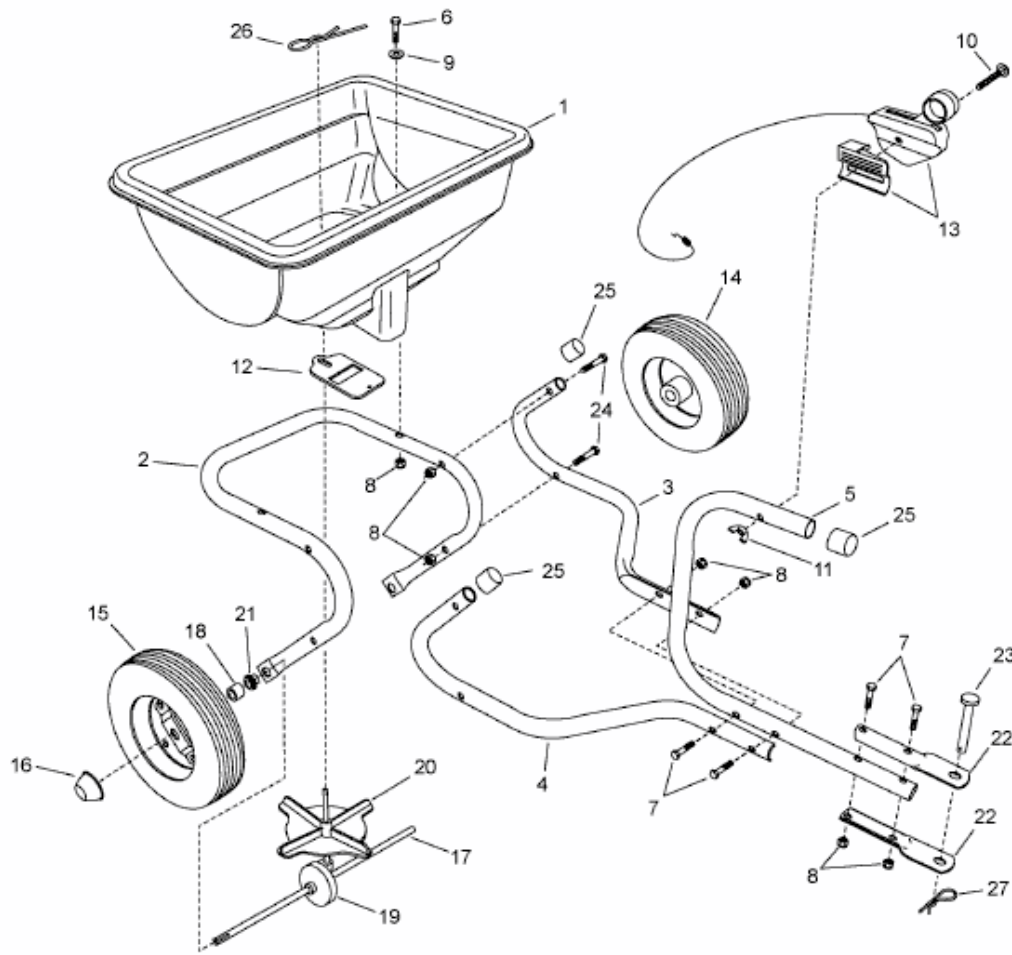

E4-01567A-01