

45-03151 (196-031-000) > 196-031-000 (2005) > GRUNDGERÄT

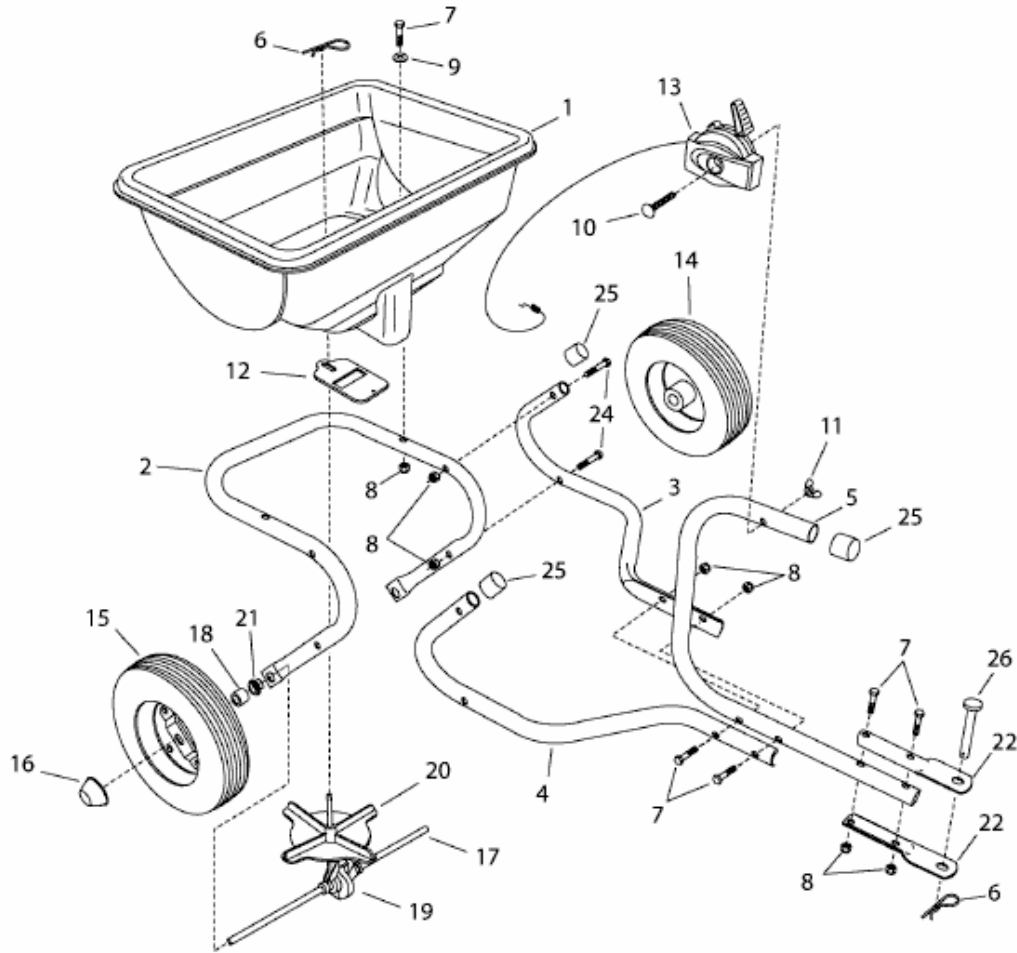

E3-02920B-01