

45-0315 (196-031-000) > 196-031-000 (2003) > GRUNDGERÄT

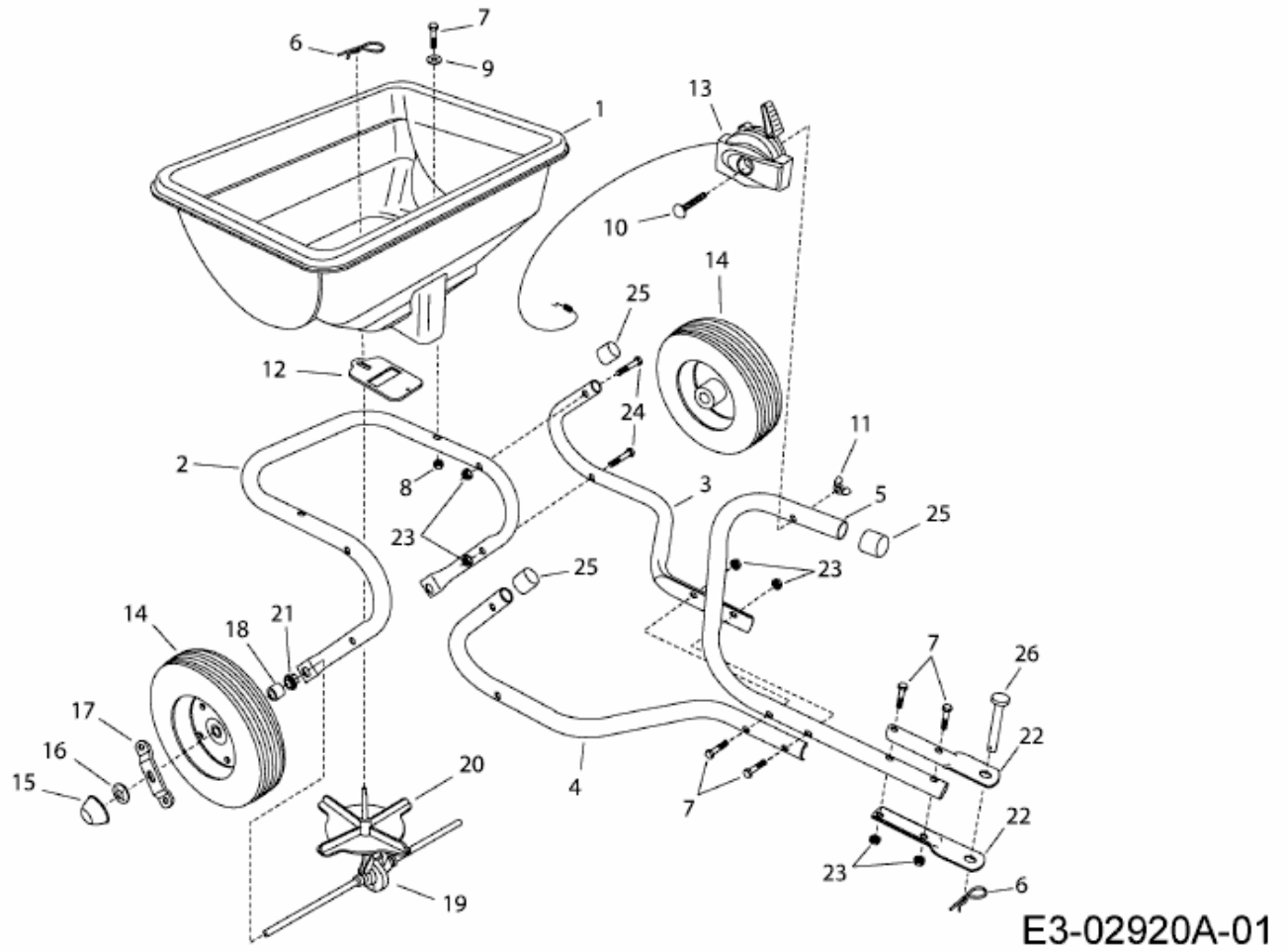

E3-02920A-01