

45-02951 (196-010-000) &gt; 196-010-000 (2010) &gt; GRUNDGERÄT

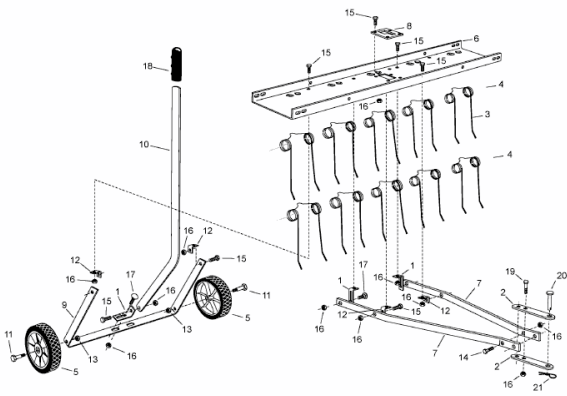

E3-08863B-01