

45-02951 (196-010-000) > 196-010-000 (2009) > GRUNDGERÄT

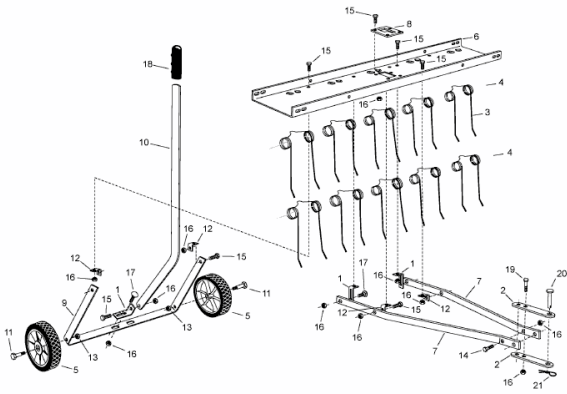

E3-08863B-01