

45-0295 (196-010-000) > 196-010-000 (2000) > GRUNDGERÄT

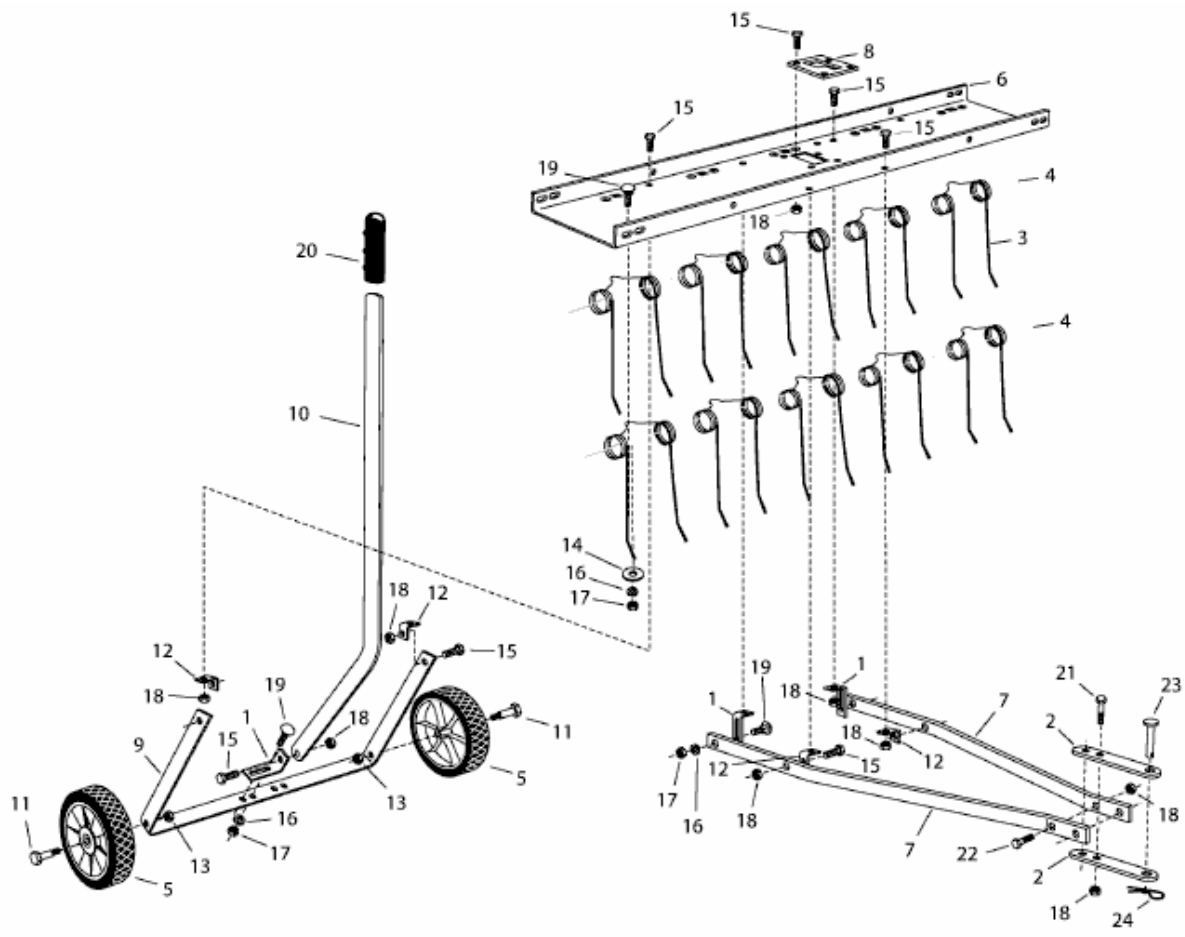

E3-08863A-01