

45-02992 (196-009-000) > 196-009-000 (2016) > GRUNDGERÄT

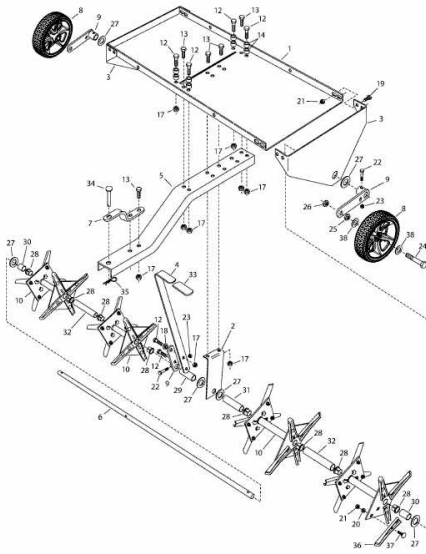

E3-08862B-01