

45-0299 (196-009-000) > 196-009-000 (2008) > GRUNDGERÄT

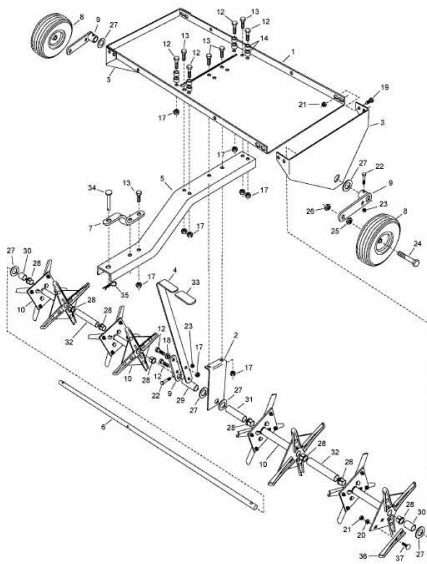

E3-08862A-01