

45-02882 (196-003-000) > 196-003-000 (2013) > GRUNDGERÄT

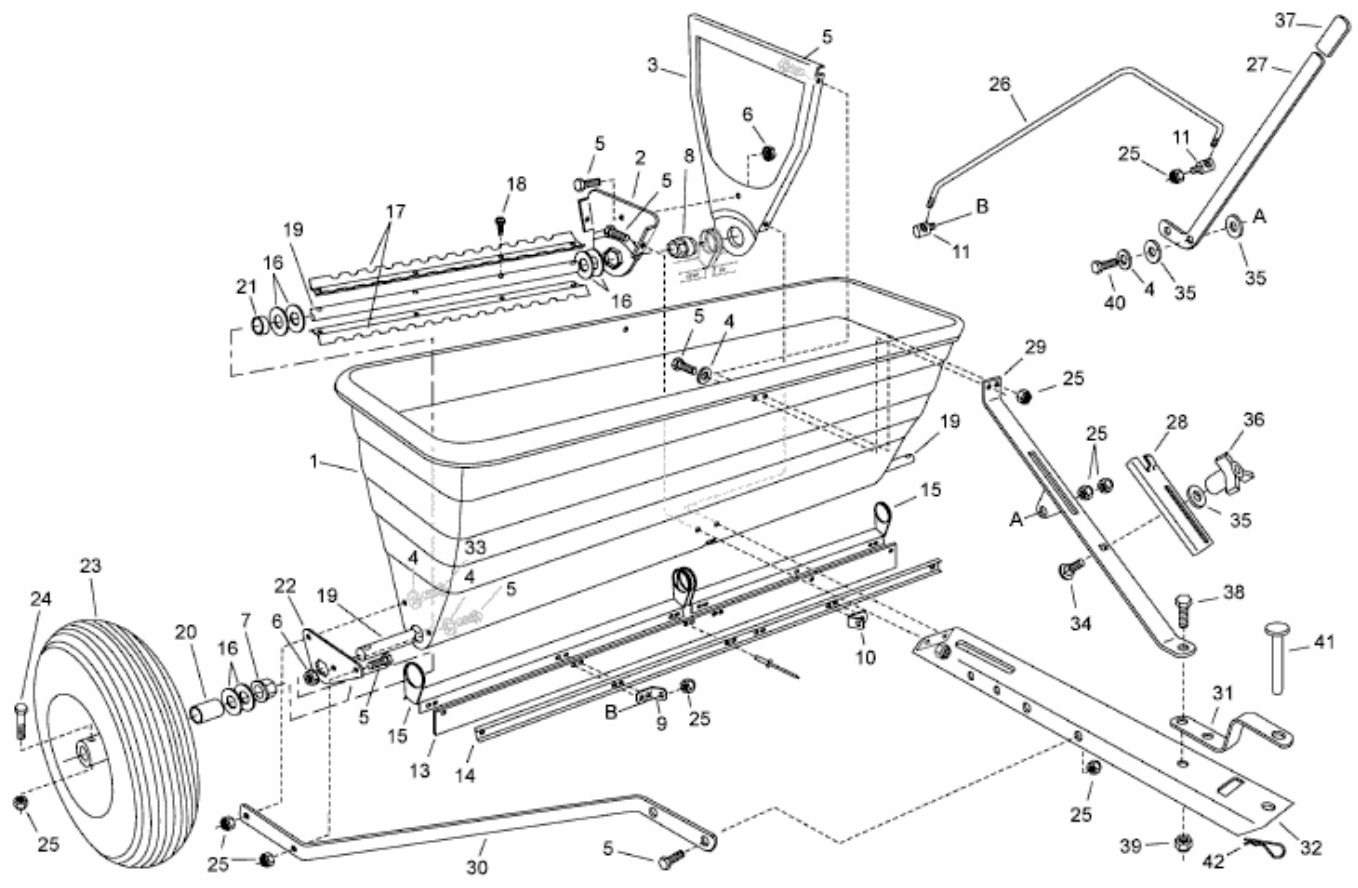

E3-08855C-01