

45-02881 (196-003-000) > 196-003-000 (2001) > GRUNDGERÄT

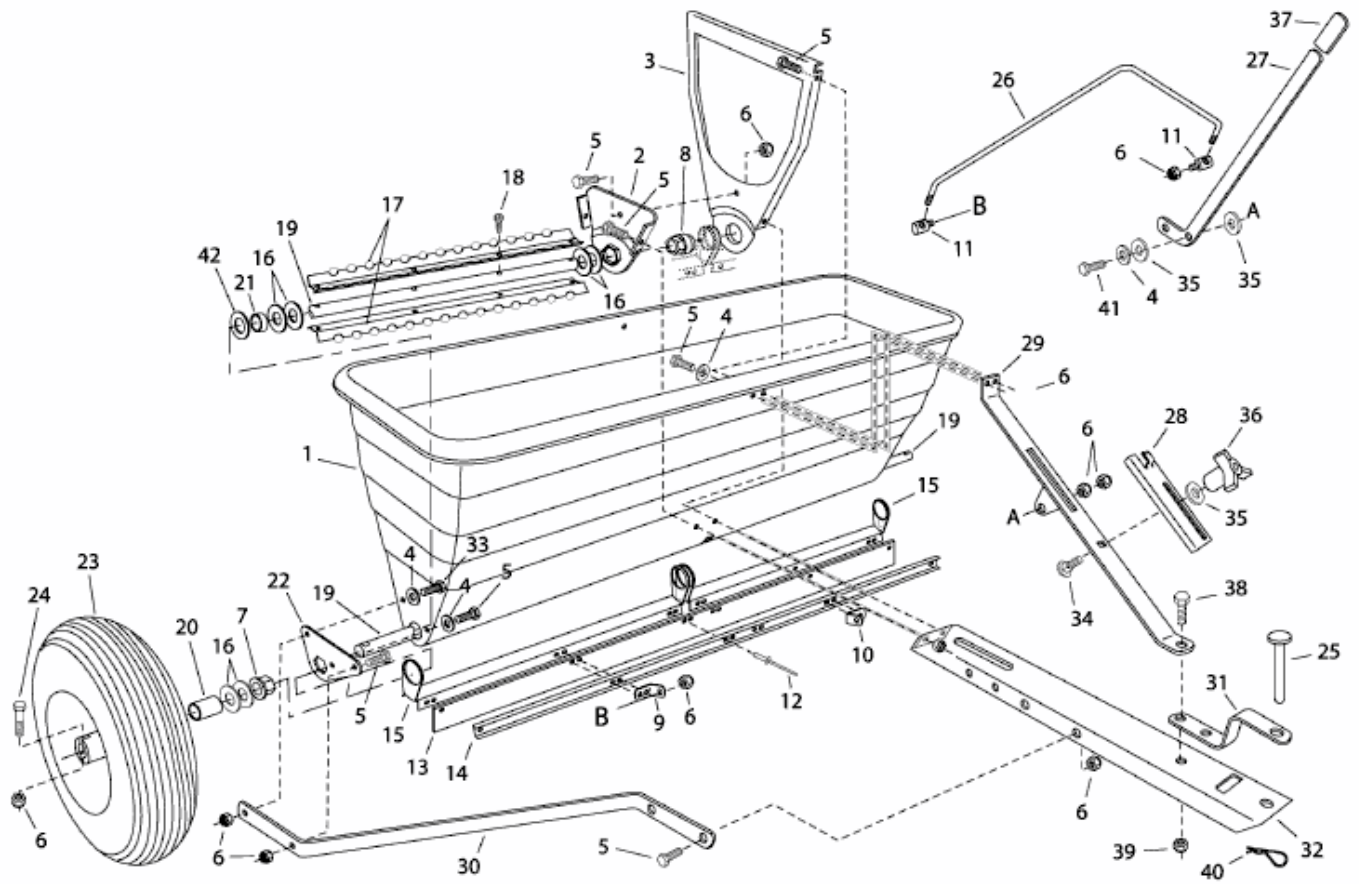

E3-08855B-01