

45-0288 (196-003-000) > 196-003-000 (1999) > GRUNDGERÄT

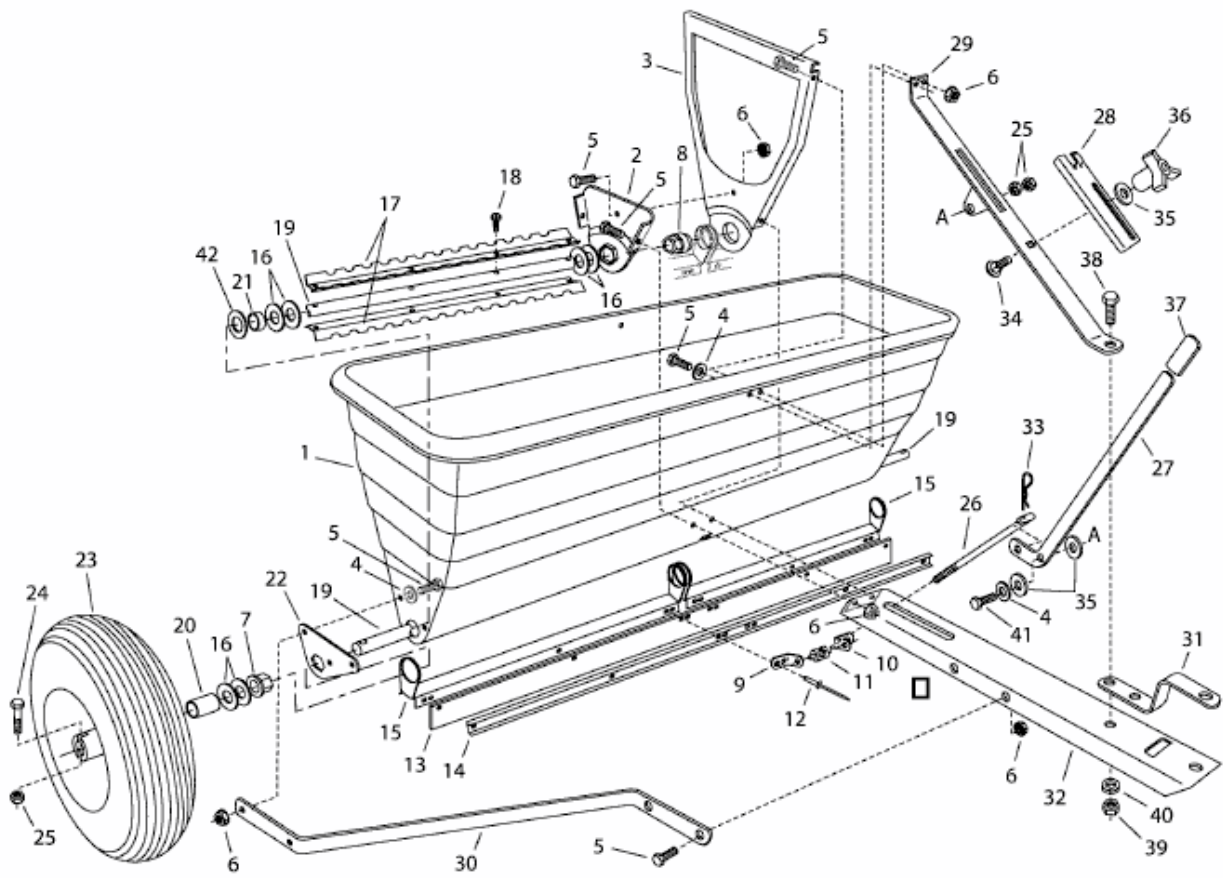

E3-08855A-01