

45-02934 (190-537-000) > 190-537-000 (2013) > GRUNDGERÄT

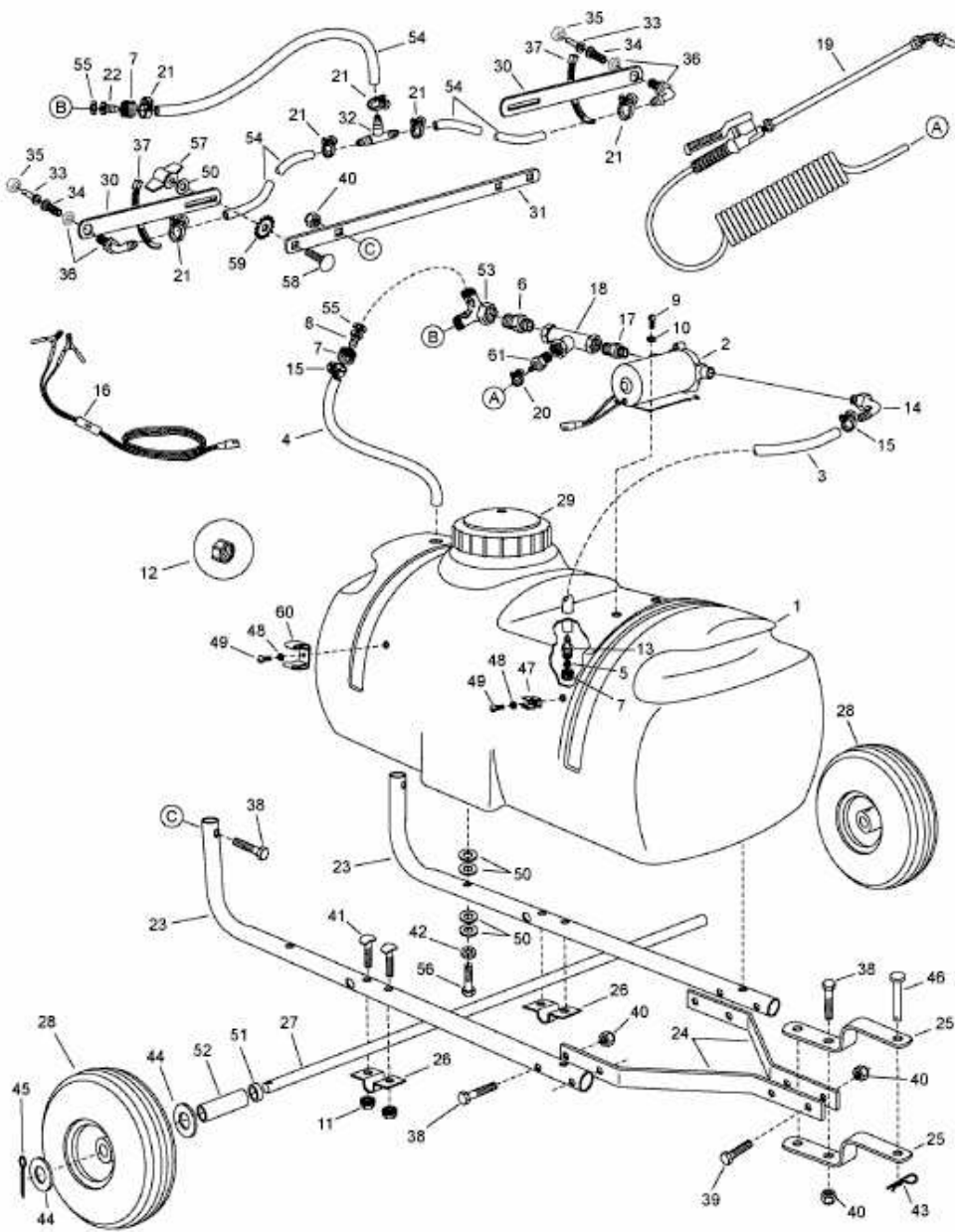

E4-01052D-01