

45-02933 (190-537-000) > 190-537-000 (2011) > GRUNDGERÄT

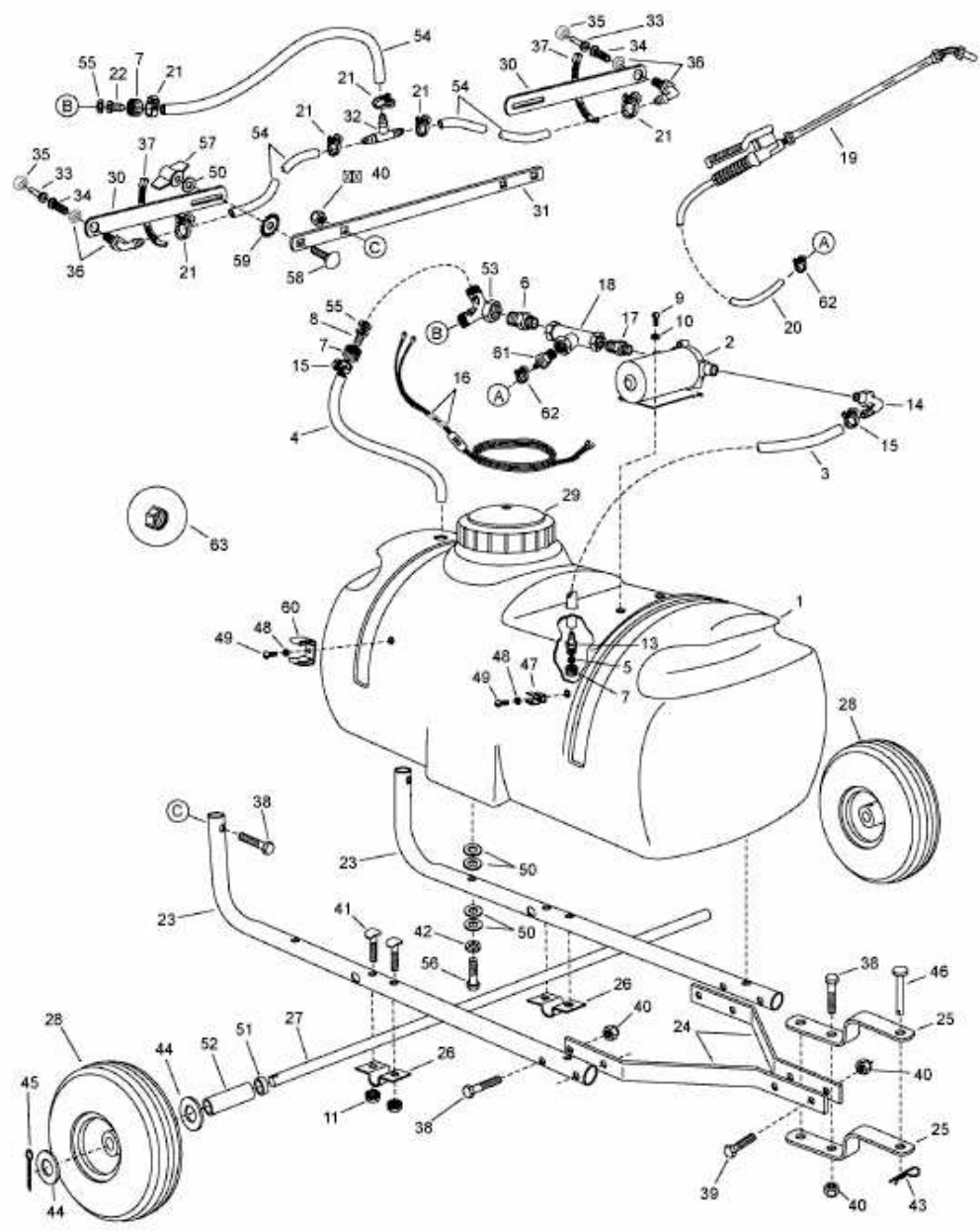

E4-01052C-01