

45-02931 (190-537-000) > 190-537-000 (2003) > GRUNDGERÄT

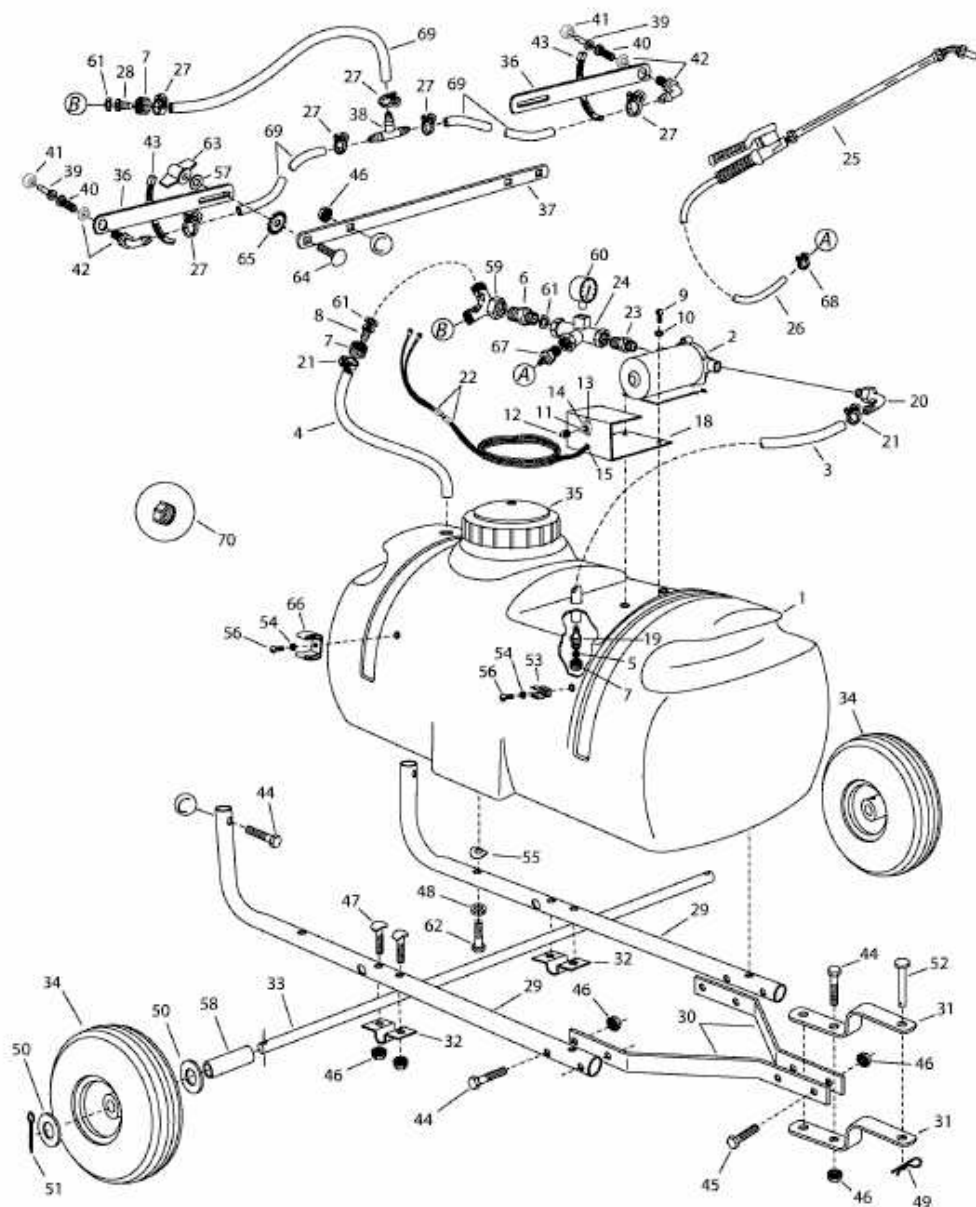

E4-01052A-01