

45-0293 (190-537-000) > 190-537-000 (2000) > GRUNDGERÄT

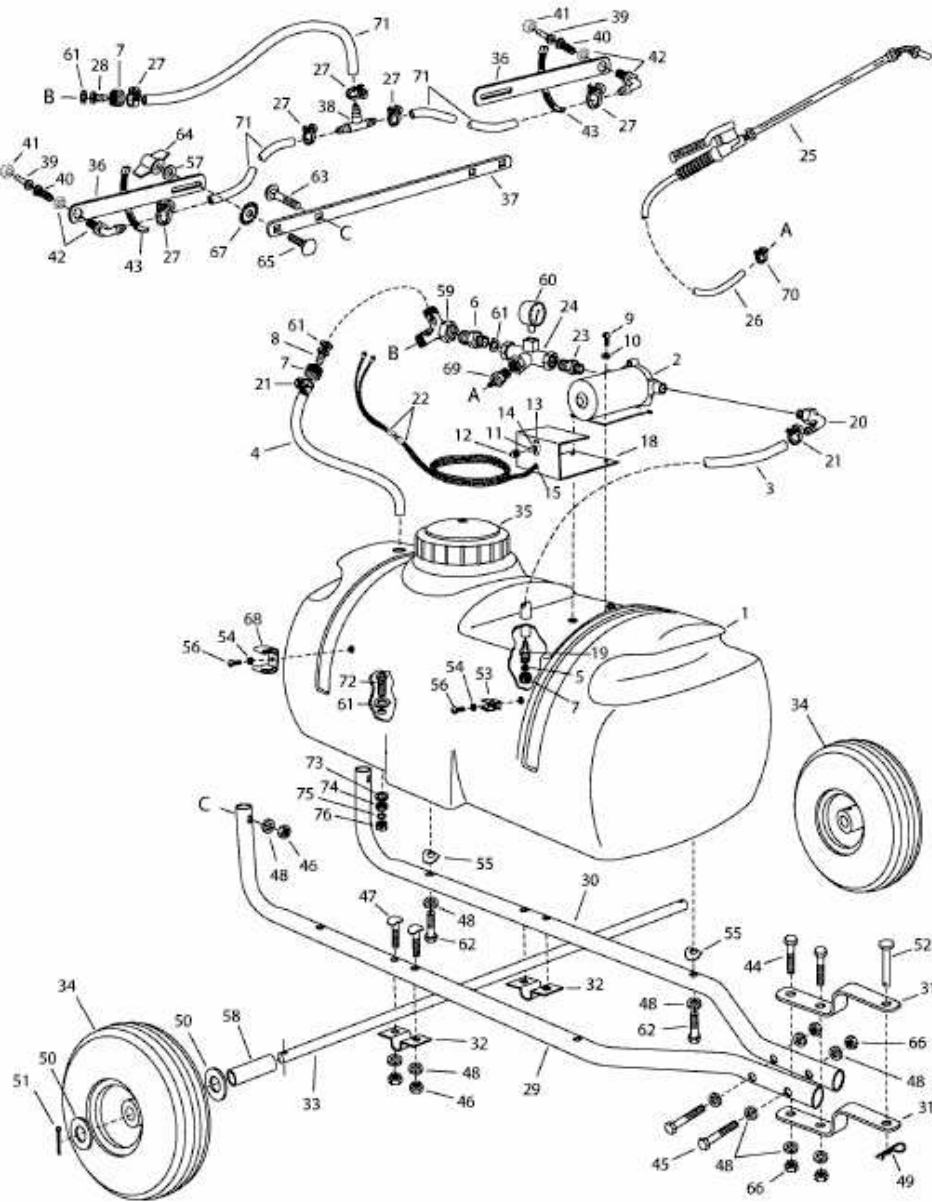

E4-01052A-00