

45-02941 (190-526-000) > 190-526-000 (2016) > GRUNDGERÄT

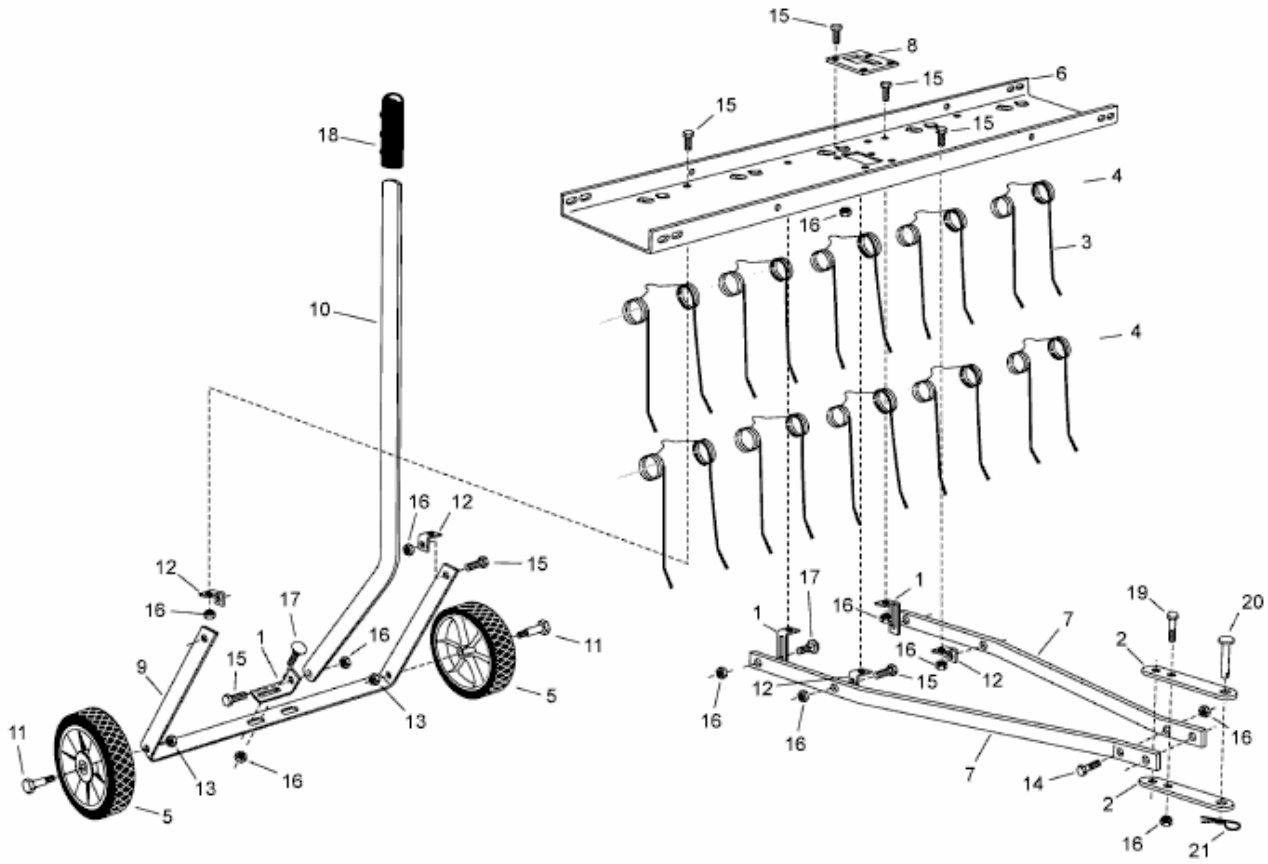

E3-09978A-01