

45-02941 (190-526-000) > 190-526-000 (2012) > GRUNDGERÄT

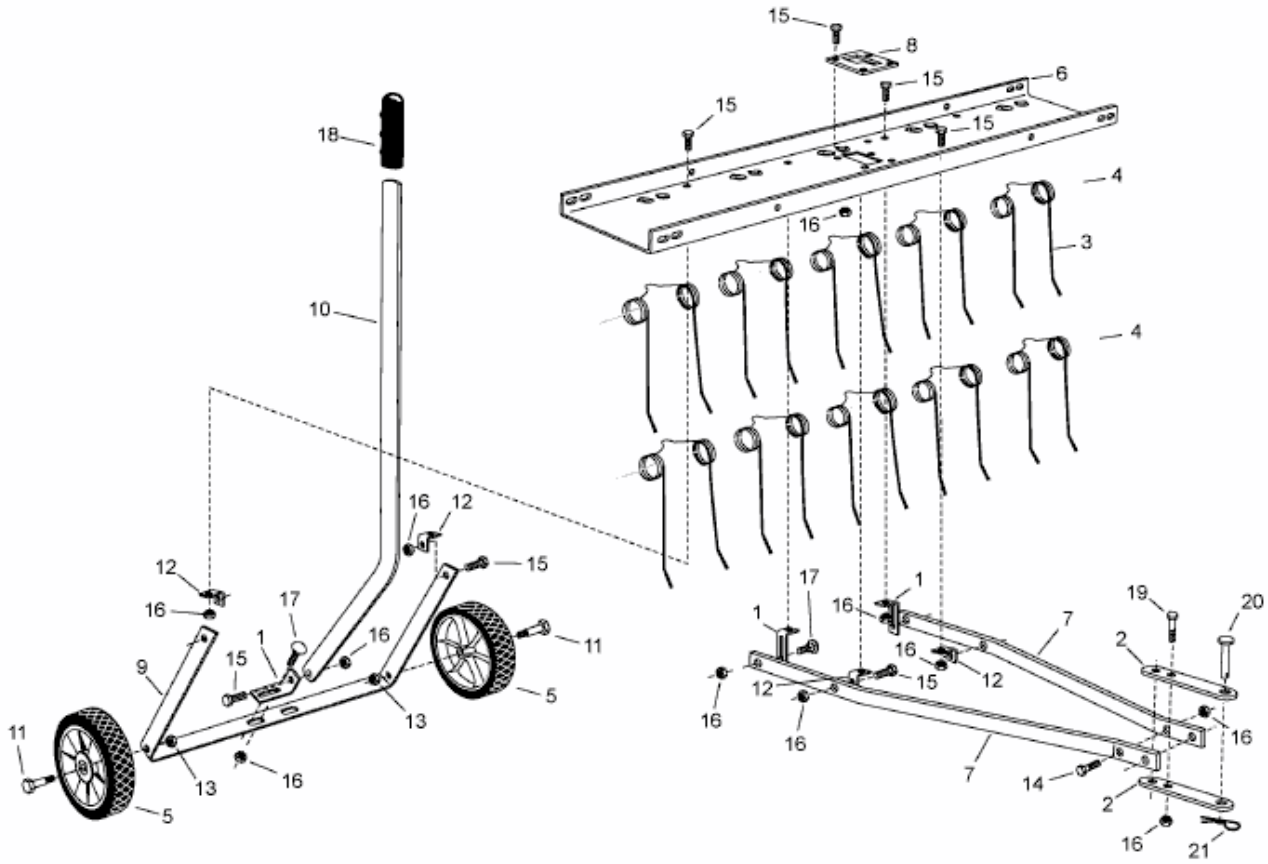

E4-00967B-01