

45-0294 (190-526-000) > 190-526-000 (2002) > GRUNDGERÄT

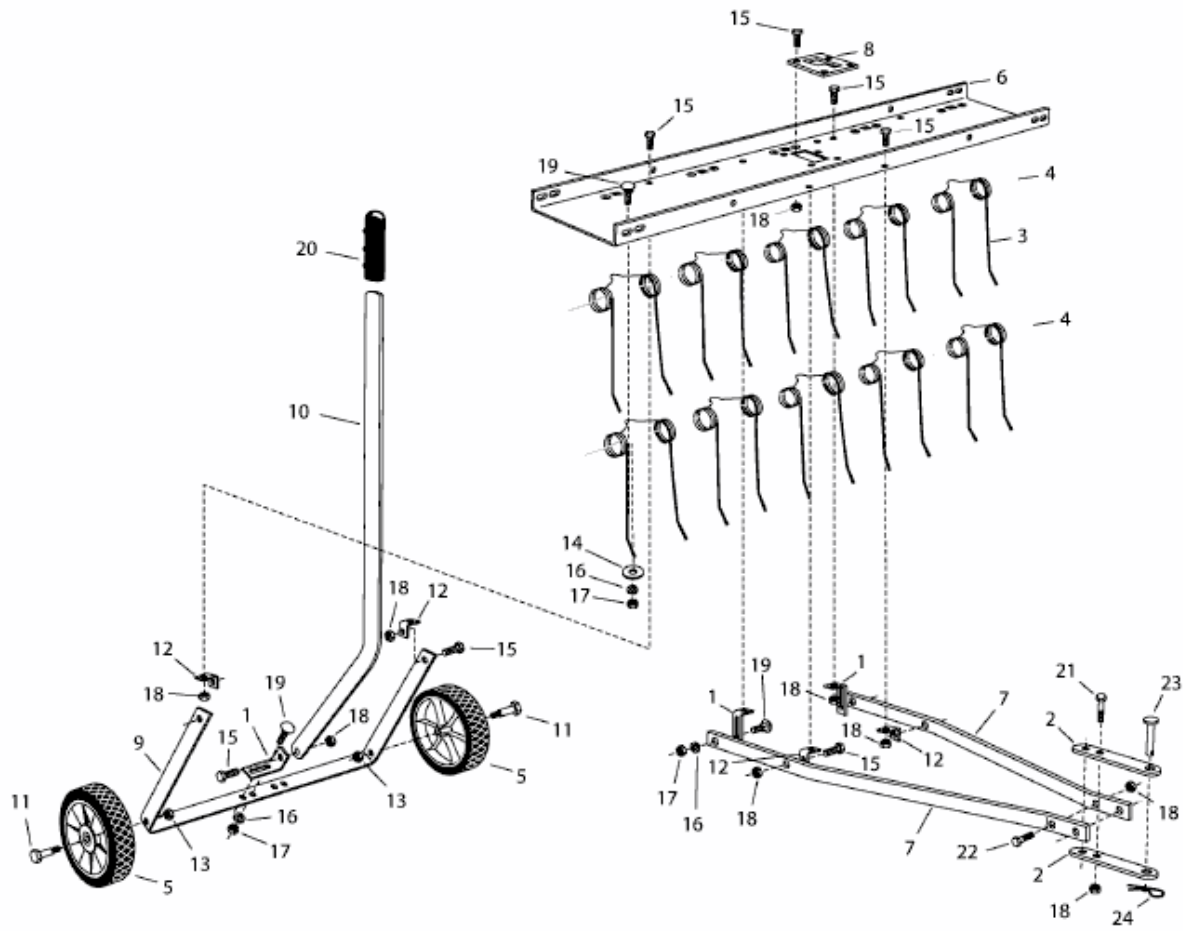

E4-00967A-01