

45-02153 (190-525-000) > 190-525-000 (2014) > GRUNDGERÄT

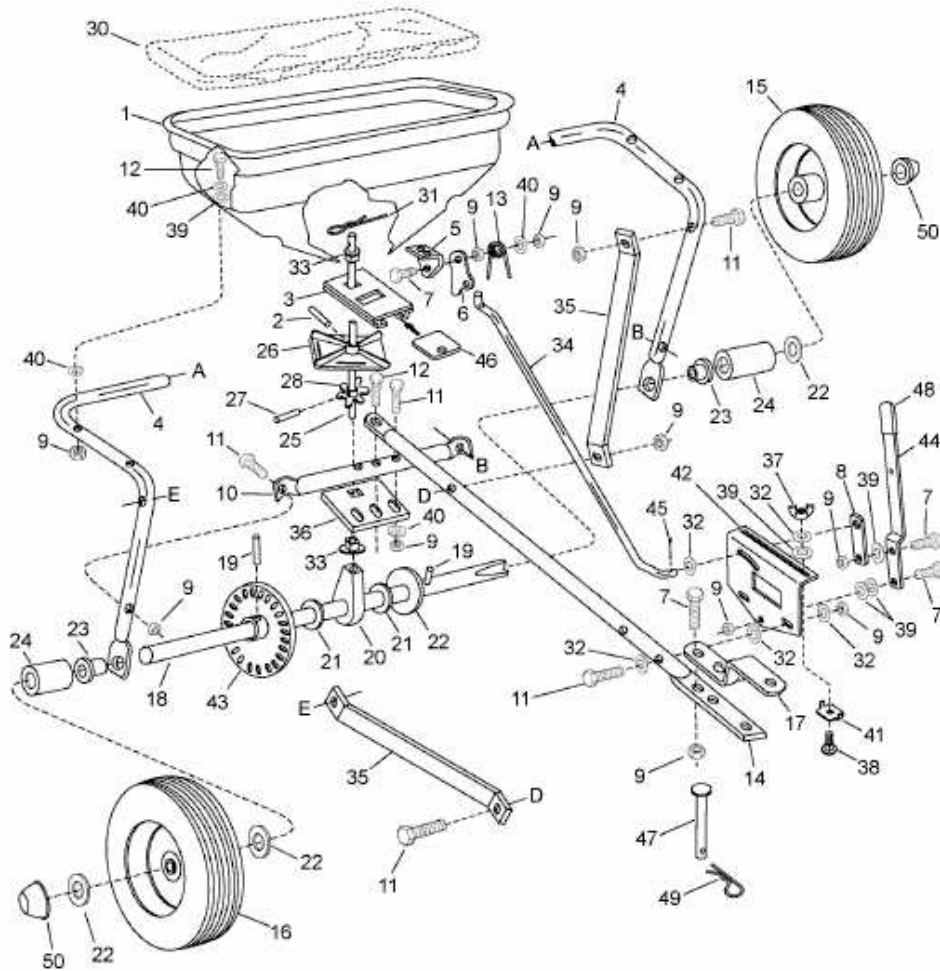

E3-08854A-01