

45-02151 (190-525-000) > 190-525-000 (2001) > GRUNDGERÄT

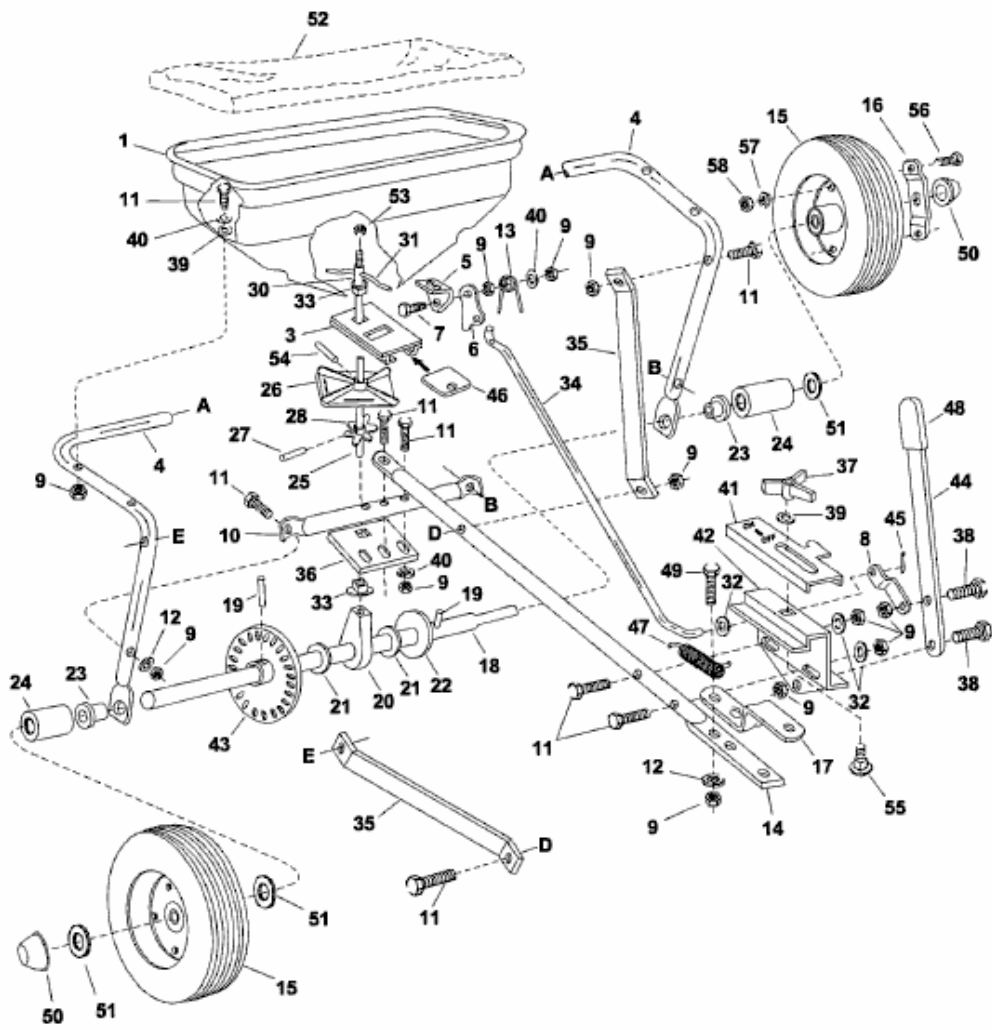

E4-01040A-01