

45-02143 (190-524-000) > 190-524-000 (2014) > GRUNDGERÄT

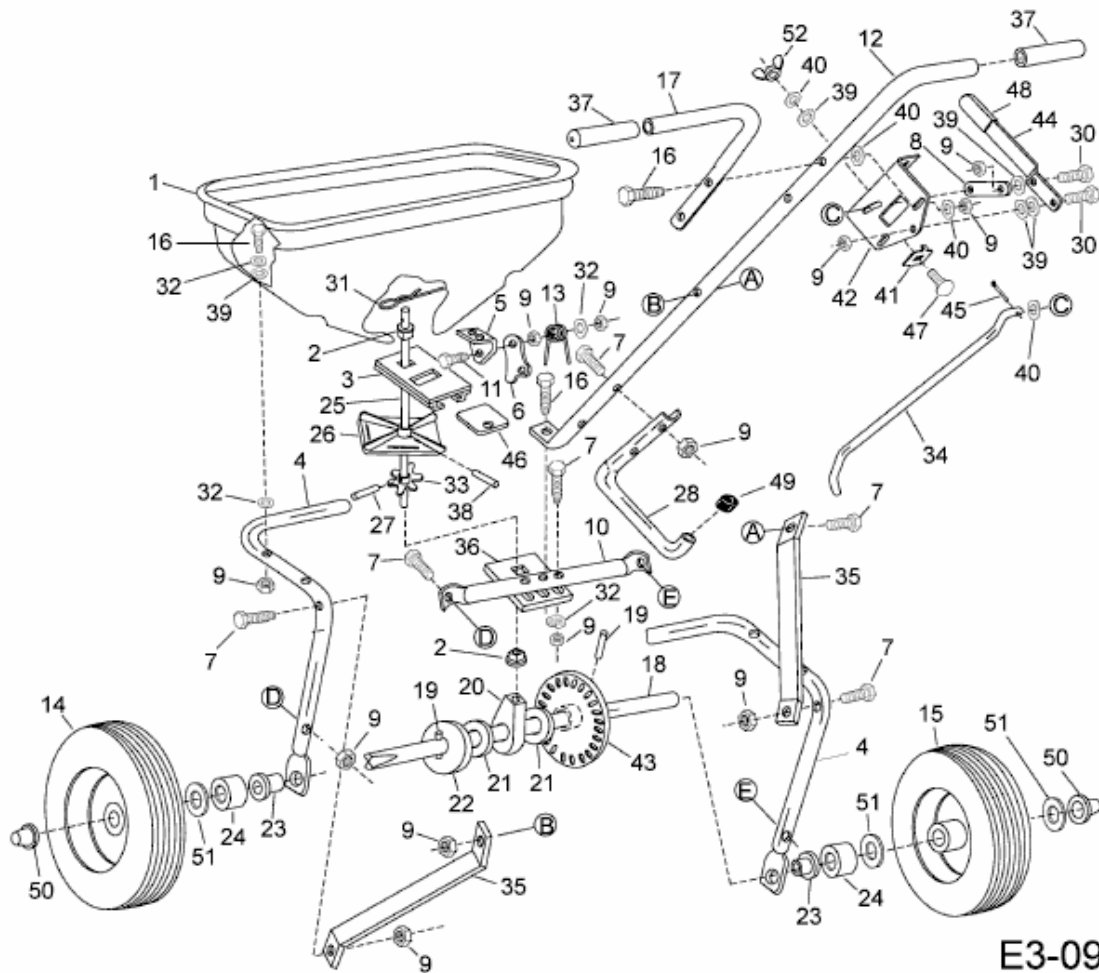

E3-09408D-01