

45-02142 (190-524-000) > 190-524-000 (2007) > GRUNDGERÄT

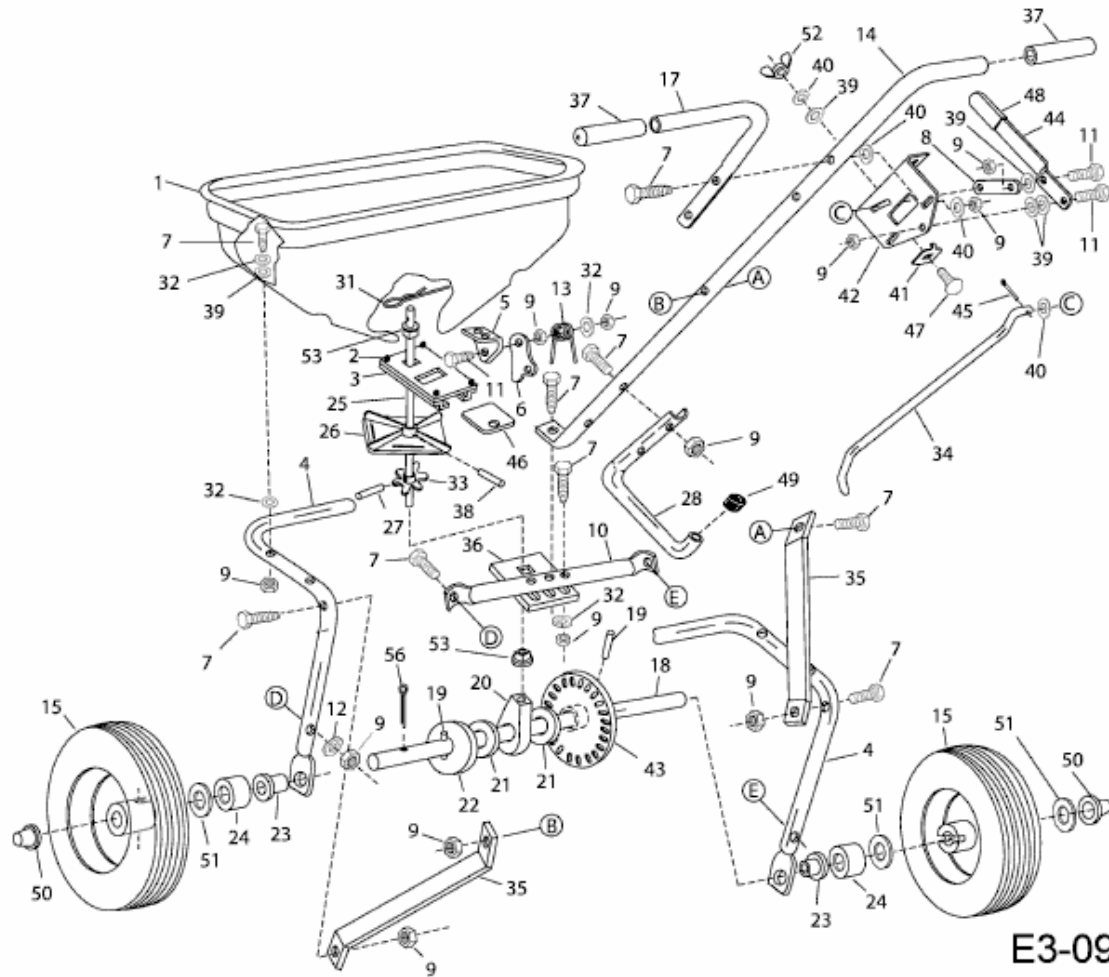

E3-09408C-01