

45-02141 (190-524-000) > 190-524-000 (2003) > GRUNDGERÄT

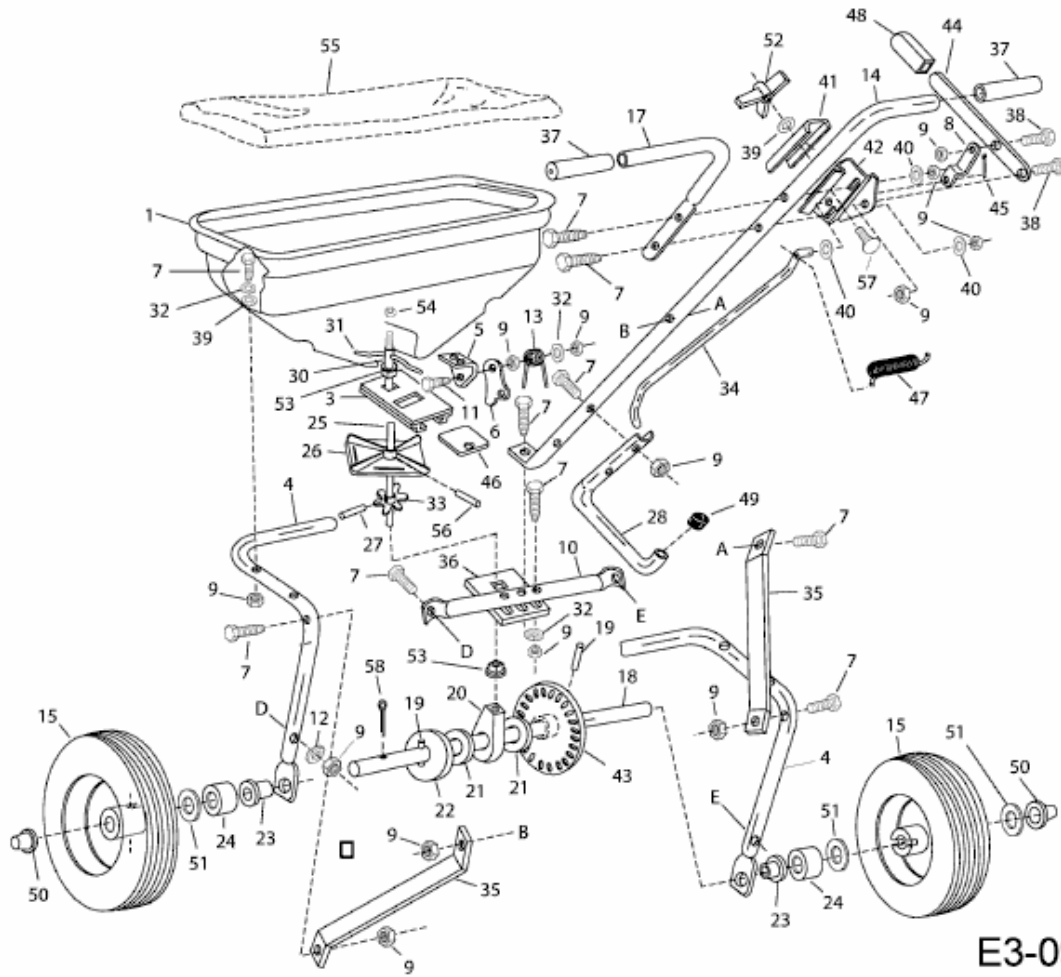

E3-09408B-01