

45-0346 (190-224A000) &gt; 190-224A000 (2015) &gt; GRUNDGERÄT

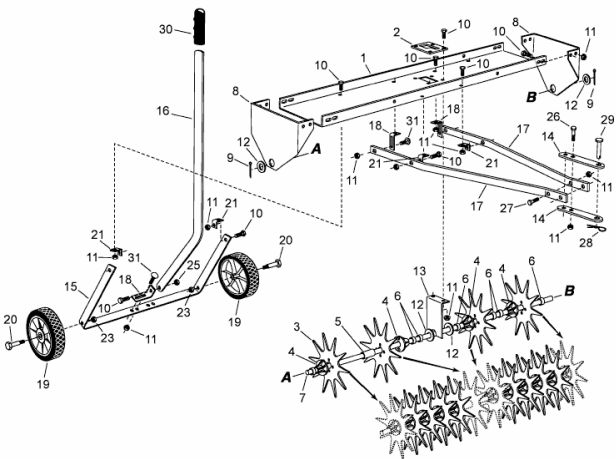

E4-01170A-01