

45-0346 (190-224A000) > 190-224A000 (2008) > GRUNDGERÄT

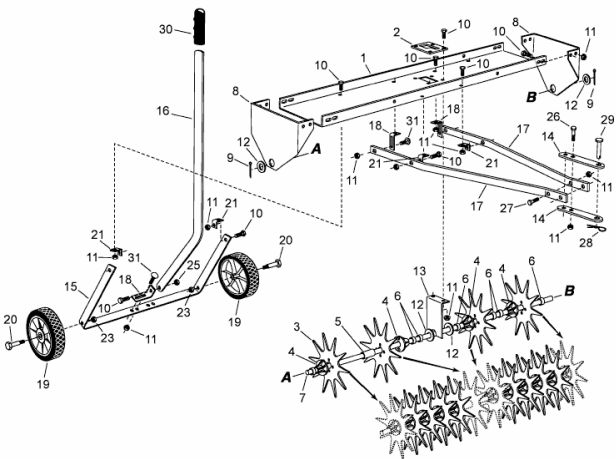

E4-01170A-01