

SMART CART (45-0464) > 190-165-000 (2011) > GRUNDGERÄT

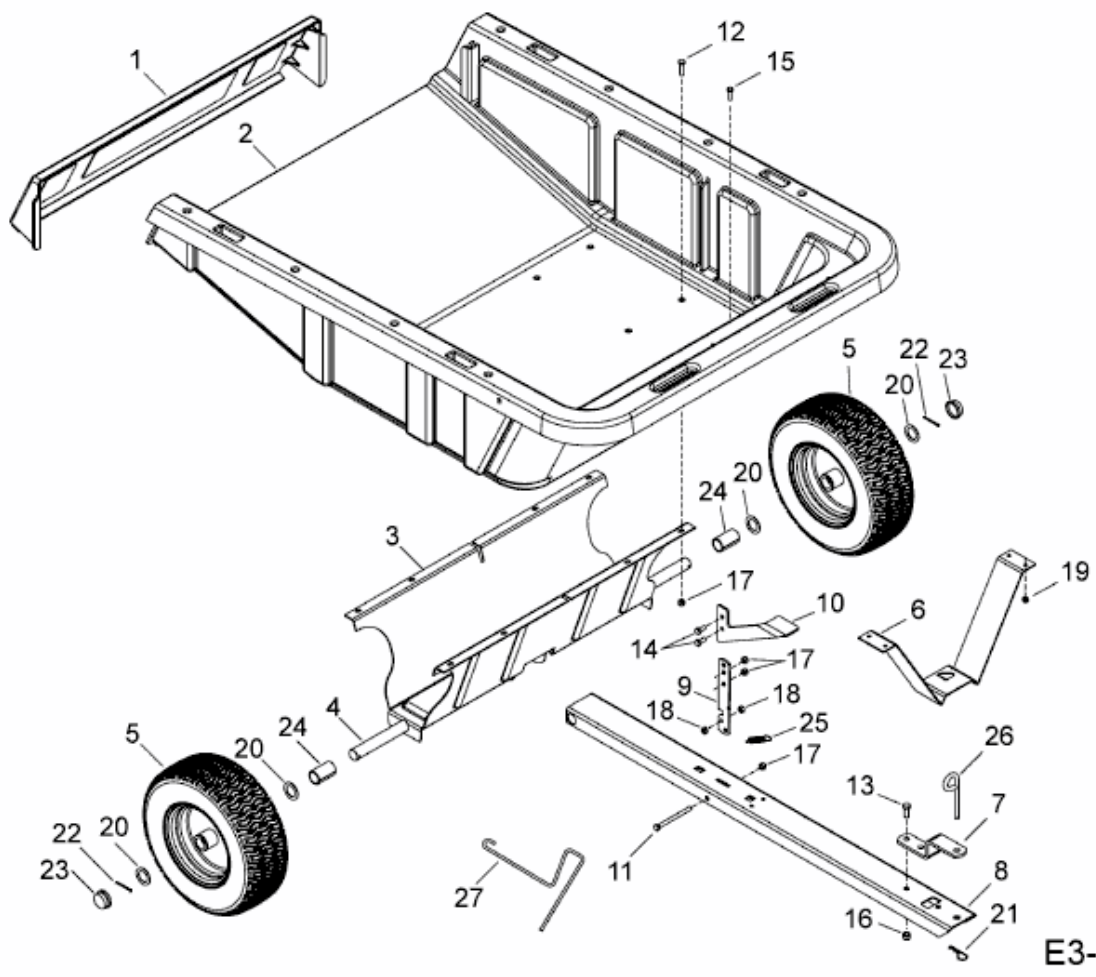

E3-06513A-01