

45-02926 (190-155-000) > 190-155-000 (2016) > GRUNDGERÄT

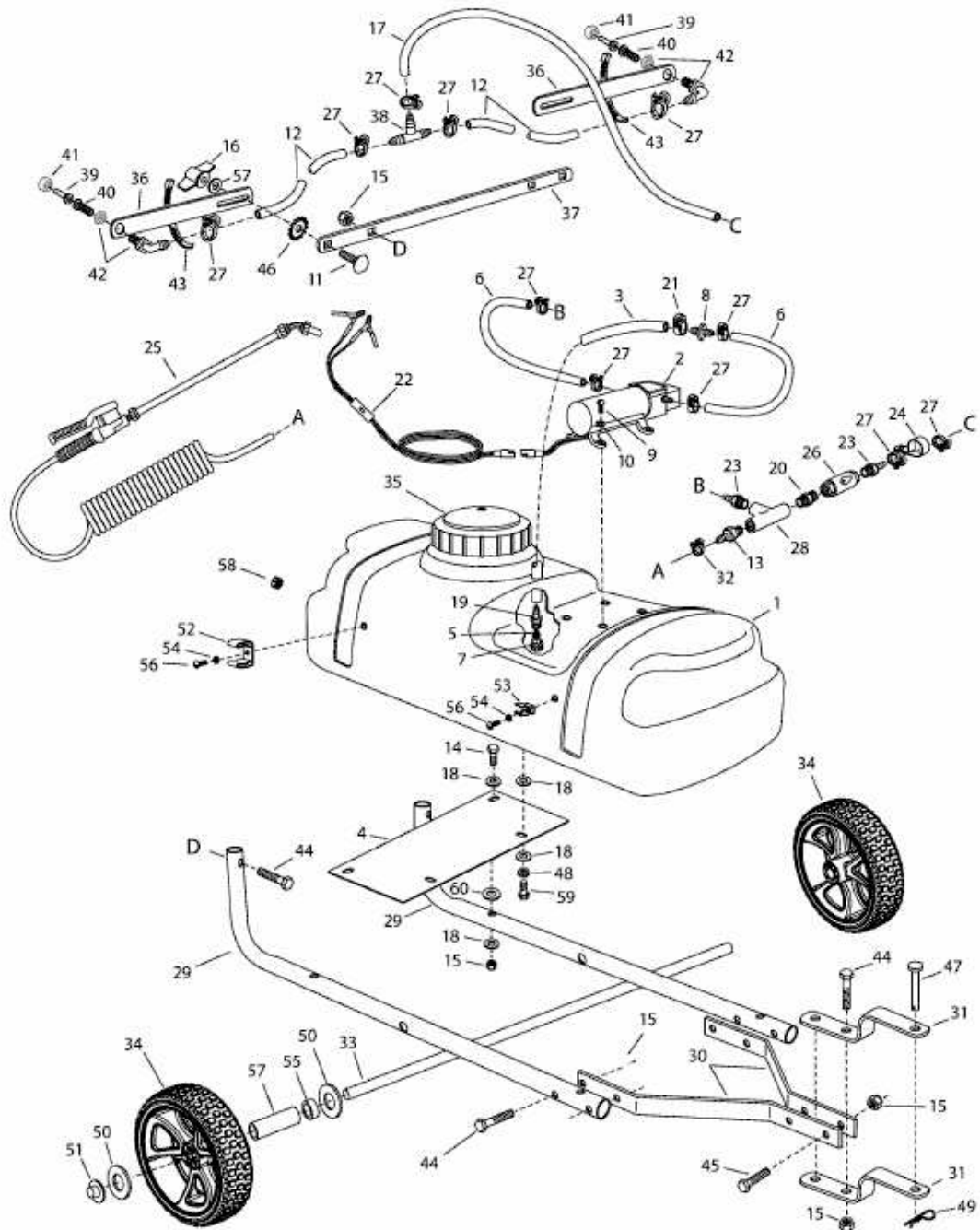

E3-09984F-01