

FÜR 400 SERIE > 190-065-678 (2001) > GRASFANGKORB

Model 065

196-065-678

Twin Bag

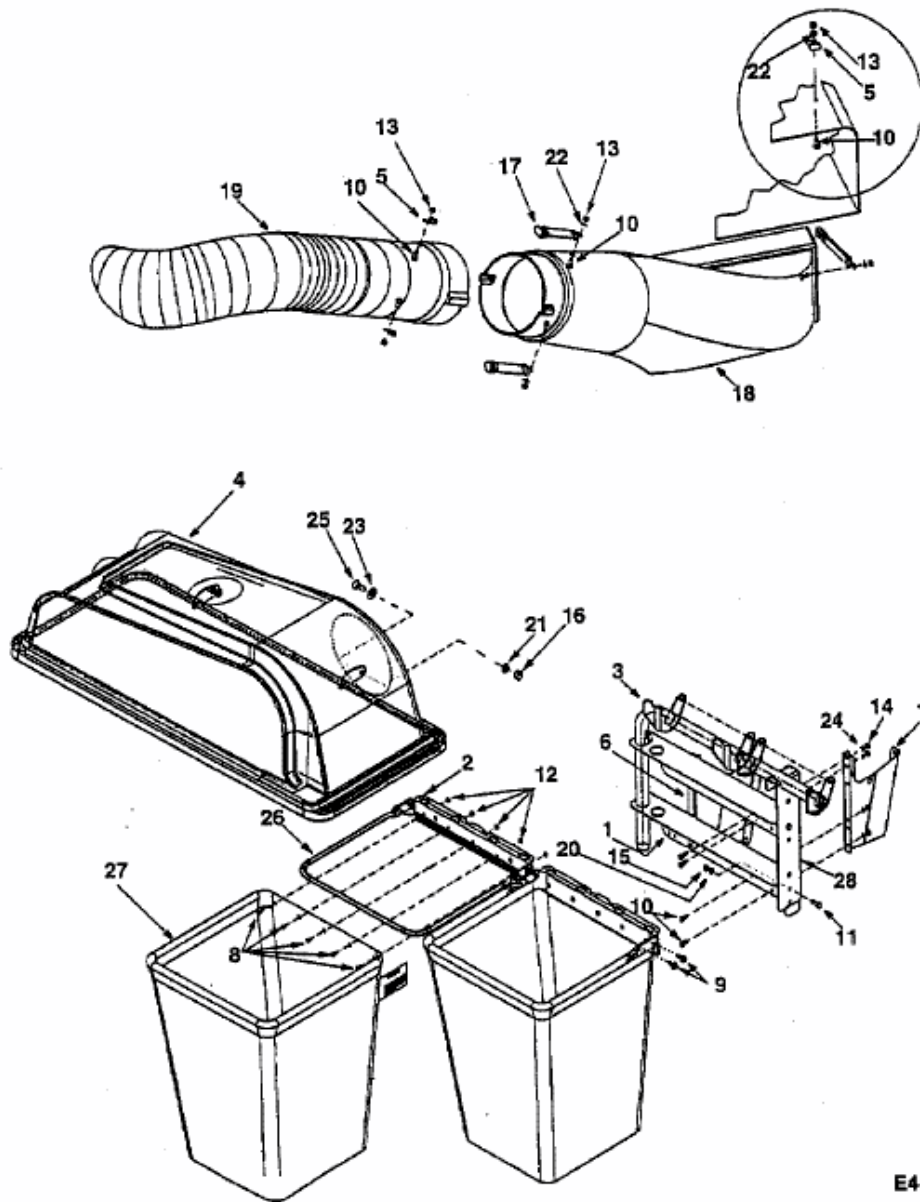

E4-01015A