

45-0329 (190-036-000) > 190-036-000 (2004) > GRUNDGERÄT

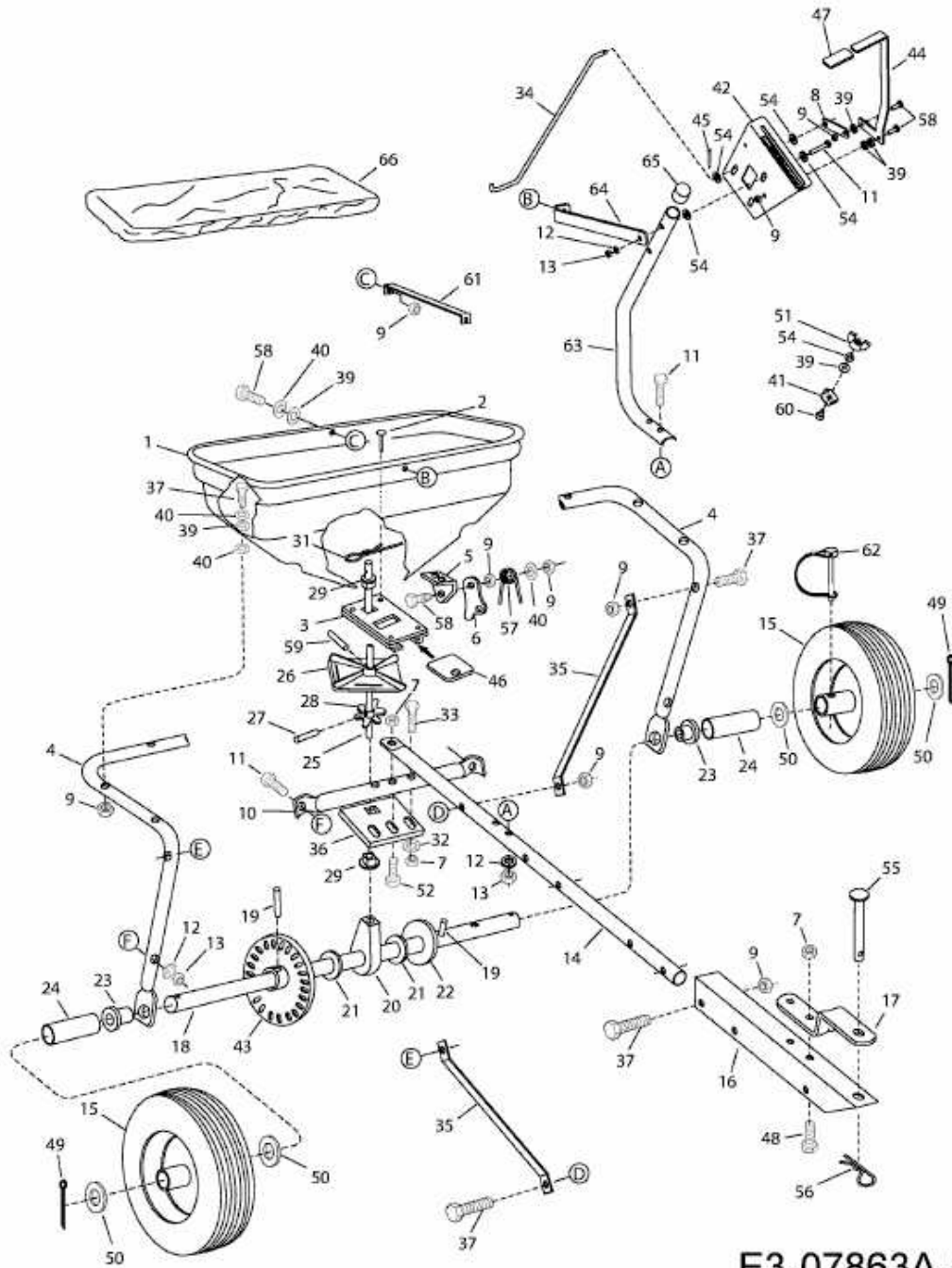

E3-07863A-01