

1032 E > 18F-C3D-668 (2004) > GRUNDGERÄT

E 32 W - E 32 W CH - 1032 E - 1032 E CH
18D-C3D-678 - 18D-C3D-684 - 18F-C3D-668 - 18F-C3D-684

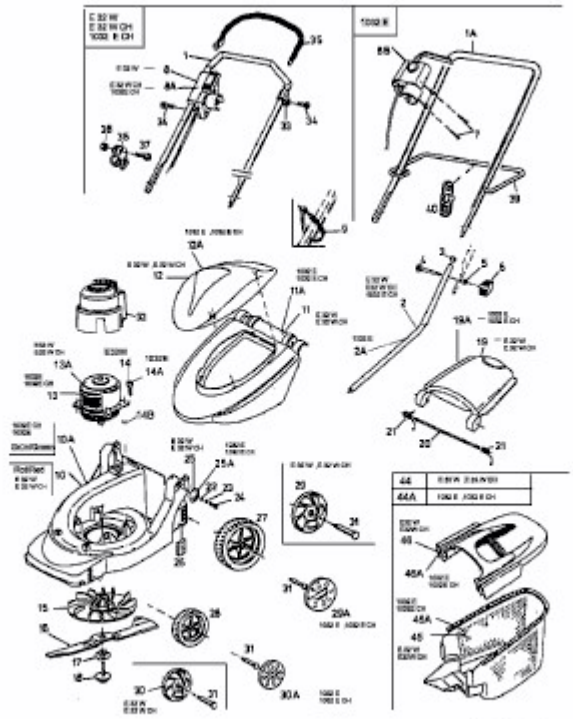

E3-01551D