

# 1032 E > 18E-C3D-664 (2003) > GRUNDGERÄT

E 32 W , E 32 W CH , 1032 E CH , 1032 E  
18D-C2D-678 , 18D-C2D-664 , 18E-C3D-664 , 18E-C3D-668

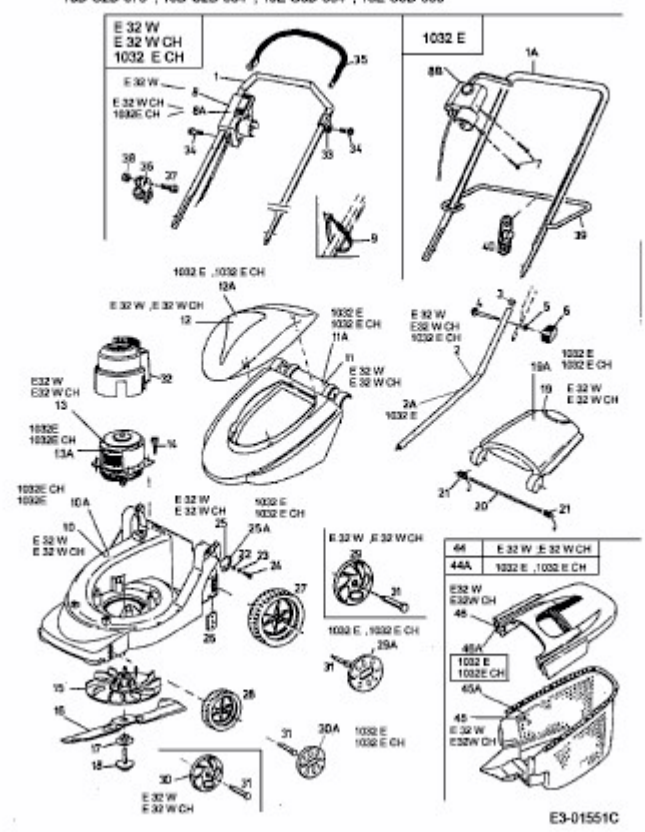

E3-01551C