

E 45 > 18D-T4H-678 (2005) > GRASFANGKORB, HECKKLAPPE, HOLM

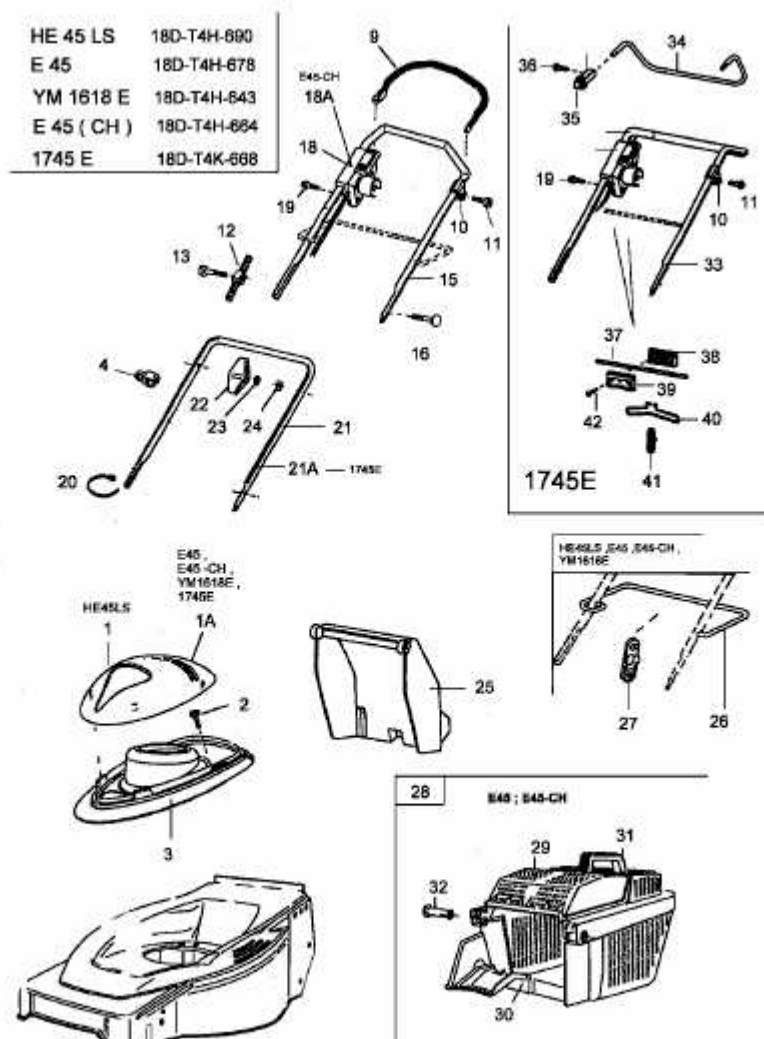

E3-02520A