

E 33 W > 18D-M4D-678 (2010) > ELEKTROMOTOR, MESSERAUFNAHME

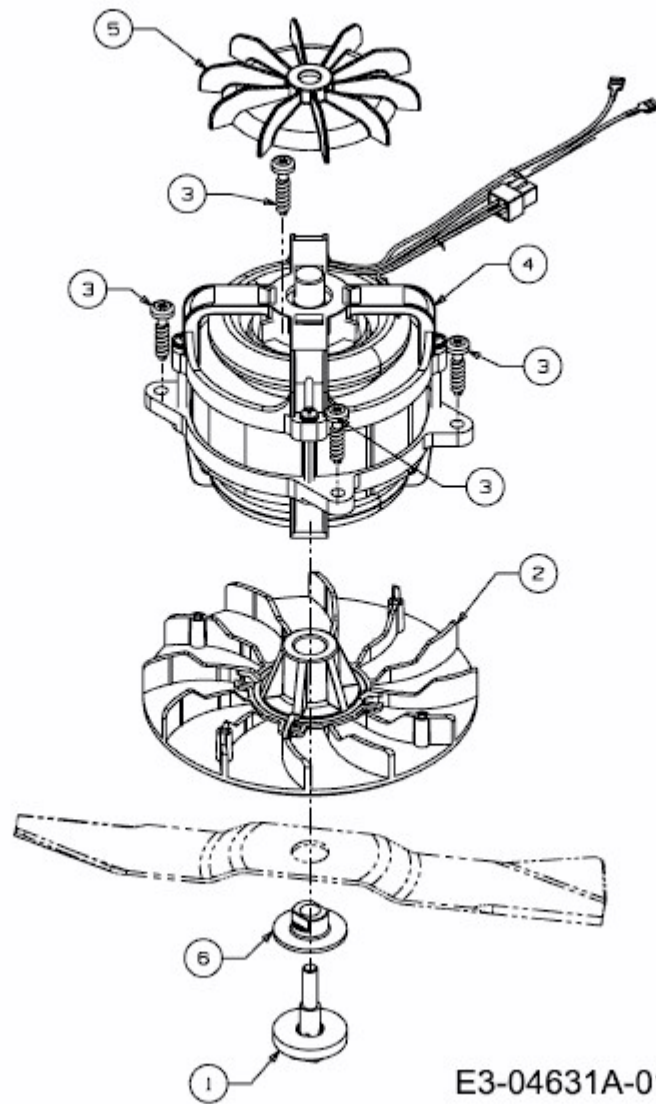

E3-04631A-01