

E 33 W > 18D-M4D-602 (2008) > ELEKTROMOTOR, MESSER

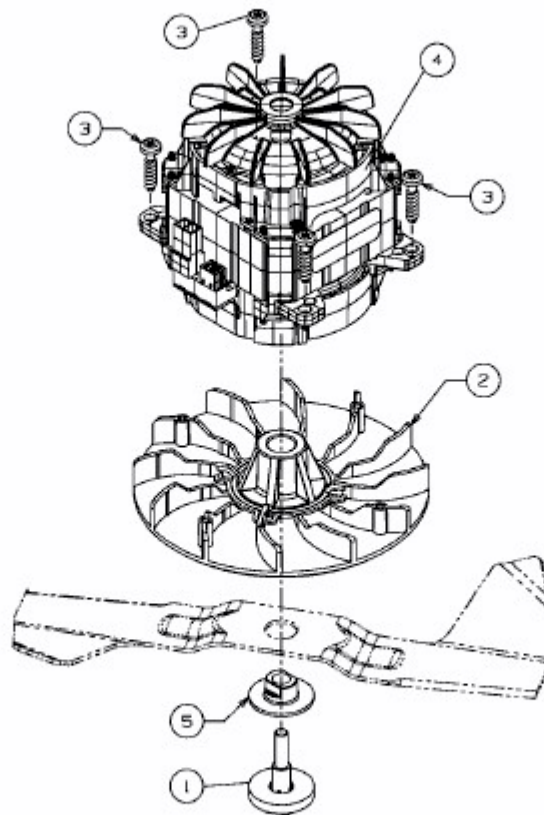

E3-03960A-01